

SD1 + Speech Dialler



Operators Manual

Contents

<i>Getting Started: SD1+ Menu Options</i>	1
<i>Overview</i>	2
<i>Connections</i>	2
<i>Passcode</i>	2
<i>Passcode Type</i>	2
<i>Programmable Output</i>	2
<i>Call Routing</i>	2
<i>Call Abort</i>	3
<i>Last Call Log</i>	3
<i>Acknowledgement Options</i>	3
<i>Telephone Numbers</i>	3
<i>Recording Messages</i>	3
<i>Deleting Phrases & Numbers</i>	3
<i>Playing Back Messages</i>	3
<i>Sending a Test Call</i>	3
<i>Three Way Calling</i>	3
<i>Programming: Initialising The SD1+</i>	4
<i>Changing Your Passcode</i>	4
<i>Changing Your Passcode Type</i>	5
<i>Programmable Output</i>	5
<i>Call Routing</i>	6
<i>Abort Options</i>	6
<i>Viewing The Last Call Log</i>	7
<i>Acknowledgement Options</i>	7
<i>Programming: Telephone Numbers</i>	8
<i>Forcing The SD1+ to Tone / Pulse Dial</i>	9
<i>Programming a Pause into the Telephone Number</i>	10
<i>Programming a Pager Number</i>	11
<i>Recording Messages</i>	12
<i>Deleting Phrases & Telephone Numbers</i>	13
<i>Testing the SD1+: Call Acknowledgement Procedure</i>	14
<i>Playing Back Messages</i>	14
<i>Sending A Test Call</i>	15
<i>General: Three Way Calling</i>	16
<i>Display Messages</i>	16
<i>Trouble-Shooting Guide</i>	17
<i>Quick Reference: Dialler Options</i>	18
<i>Quick Reference: Advanced Options</i>	18

Getting Started: SD1 + Menu Options

All of the SD1+ menu options are accessed by entering the user passcode (default 1234). These menu options allow all the necessary programming of the SD1+ and are selected by pressing the relative "Hot Key" as shown in the table below. A summary of menu options and their relative "Hot Key" is also shown to the right.

Hot Key	Menu Option	Page
[1]	Not Used	
[2]	Not Used	
[3]	Not Used	
[4]	Change Passcode	4
[5]	Change The Passcode Type	5
[6]	Programmable Output	5
[7]	Call Routing	6
[8]	Abort Options	6
[9]	Viewing The Last Call Log	7
[0]	Acknowledgement Options	7
[ENT] [1] - [4]	Program Phone Number 1, 2, 3 or 4	8 - 11
[ENT] [0] - [D]	Record Phrase 0, A, B, C or D	12
[ENT] [ENT]	Delete Phrases & Phone Numbers	13
[A] [B] [C] or [D]	Playback Messages A, B, C or D	14
[A] [1] - [4] [B] [1] - [4] [C] [1] - [4] [D] [1] - [4]	Send Message A, B, C or D to Telephone Number 1, 2, 3 or 4	15

SD1+

[?] [?] [?] [?]

READY

[4] Change passcode
NEWCODE-

[5] Change Code Type
C,TYPE-

[6] Program Output
OUTPUT-

[7] Call Routing
ROUTE-

[8] Abort Options
ABORT-

[9] View Event Log
VIEWLOG-

[0] Acknowledgement
CLEARBY-

[ENT] Enter Phone Numbers
or Record Messages
ENT 1-4
OR 0-0

[ENT] [ENT] Delete Options
ERASE-

[A] [B] [C]
or [D] Replay Message's
A, B, C or D
Send To Phone
No's 1, 2, 3 or 4
1-4 / ENT
TO SEND

Overview

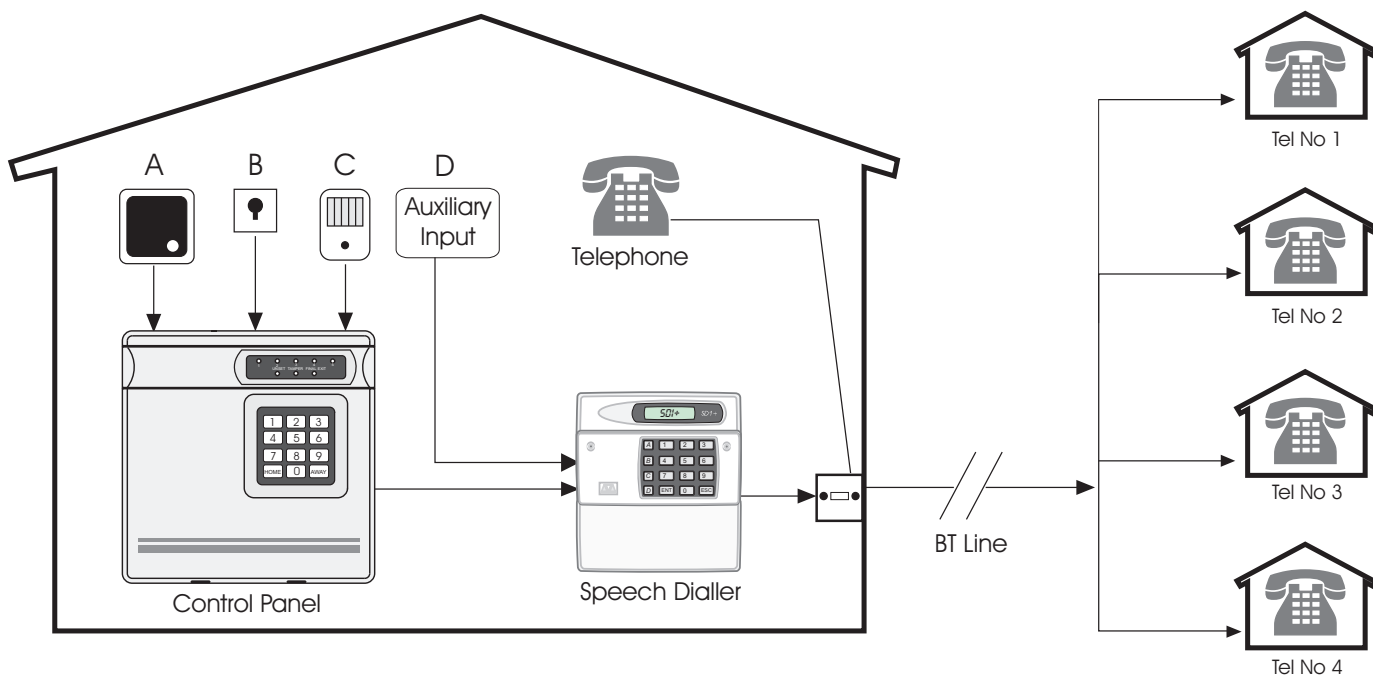

This product is manufactured to meet all European Economic Area Tele-communication networks requirements.

Connections

The SD1+ is connected between the alarm control panel and the telephone line. It behaves like another extension to the telephone and does not affect the normal operation or that of any other extensions fitted. However, if the SD1+ is operating, and any telephone handset is lifted, the messages will be heard. The unit requires no batteries as its power is derived from the alarm control panel.

The SD1+ can accept up to four inputs which in our example are; A - fire, B - Personal Attack (PA), C - burglary and D - Auxiliary. These inputs correspond to messages (A, B, C or D) that the SD1+ sends out and should be recorded as such. The SD1+ can also accept a direct connection from suitable auxiliary devices such as radio PA buttons, medical alarms or anything using volt free contacts. The abort input is used as trigger D. See page 6.

Passcode

The SD1+ requires a passcode to be entered to gain access to all of the programming menus, this code can also be used to cancel an activation if the unit has been accidentally triggered. See page 4.

Passcode Type

The passcode that is required by the SD1+ to enter into the programming menus, can be modified so that it is either a standard 4 digit code, or a 6 digit code. See page 5.

Programmable Output

The SD1+ has a programmable output that is capable of supplying up to 100mA of current. This output can be programmed to activate when the SD1+ has been triggered, when the SD1+ has been successfully acknowledged, or when the SD1+ has failed to communicate to all telephone numbers. See page 5.

Call Routing

The SD1+ can be programmed so that each trigger input A, B, C or D will only dial a certain telephone number. This can be used for when the dialler is required to call four different numbers under three different conditions e.g. trigger A will only dial telephone number 1, trigger B will only dial telephone numbers 2 & 3 whereas trigger C will dial telephone numbers 1, 2, 3 & 4. See page 6.

Call Abort

The SD1+ can be programmed so that if it is accidentally triggered, the call can be aborted. Once aborted, the dialler will stop dialling out immediately. The SD1+ can be aborted by one of the following methods: when a signal is applied to the abort input, when the input that triggered the unit is removed, or when the user passcode is entered. When an abort is performed by the code, the display shows "**ABORTED**" as visual confirmation of the abort being carried out (a chime tone will also be heard). See page 6.

Last Call Log

The SD1+ has a last call log, this enables the user to find out who the unit has dialled and who acknowledged it. The log also shows which input was triggered last. See page 7.

Acknowledgement Options

Once the SD1+ has made its call and delivered its message, it requires a signal to say that the message has been successfully received. This is done by the recipient pressing the number "8" button on their telephone. See page 14. When the SD1+ has been acknowledged, it will shut down until it is triggered again. This option determines how many times the unit must be acknowledged before it shuts down. See page 7.

Telephone Numbers

The SD1+ can dial up to four different telephone numbers. These numbers can be up to 24 digits long and are programmed using the LCD display and keypad on the unit. The numbers can be forced to tone or pulse dial if required and a pause can also be programmed. It is also possible for the SD1+ to dial a pager and send a numerical message, this message is programmed by the user (a digit is also sent after the message that corresponds to the trigger input e.g. 1, 2,3 or 4 = Trigger A, B, C or D). See pages 8-11.

Recording Messages

The SD1+ has a built-in microphone so that phrases can be recorded directly into the unit. The message that is sent by the SD1+ consists of a common phrase (0) which normally states your name & address, followed by phrase A, B, C or D which relate to the inputs applied from the control panel (PA, burglary and fire in our example). The SD1+ has up to 40 seconds of recording time which has to be shared by all 4 phrases. It must be noted that if 10 seconds is initially used by phrase 0 and you need to re-record that phrase, 10 seconds must be used by the new phrase 0. See page 12.

Deleting Phrases & Numbers

Because the SD1+ has a Non Volatile Memory (NVM), the phone numbers and messages cannot be deleted by removing power from the unit. This option, allows you to delete all phrases or all phone numbers as required. See page 13.

Playing Back Messages

Once the phrases have been recorded by the SD1+, they can be played back through the on board speaker so that you can check the recorded message. It should be noted that when you play back phrases A, B, C or D, phrase 0 is always played first. See page 14.

Sending a Test Call

Once the SD1+ has been programmed, each message can be sent to a particular number to test whether the unit is working correctly. When the unit is in this test mode, everything on the phone line will be heard through the speaker. The display will also give a visual indication of what is happening during the call. See page 15.

Three Way Calling

This is a service that is normally provided by British Telecom, if this service is enabled, the SD1+ will use it to prevent anyone trying to block the telephone line. See page 16.

Programming: Initialising The SD1 +

When you power up the SD1 + for the first time, a factory restart is required. This involves shorting out the factory restart pins (JP2) whilst applying power to the unit (please refer to the installation instructions for details). The display will show "PLEASE RECORD", this indicates that the memory is blank (i.e., all telephone numbers and messages are not programmed). Once it is programmed, "SD1+" is displayed instead. To gain access to the programming menus, the passcode must be entered (Default 1234).

1. When the unit is powered up for the very first time, the display shows "PLEASE RECORD".

 When programmed, the display shows "SD1+" (fig 2).

2. Enter the default user code to initialise the unit ready for programming.
3. When initialised the display shows "READY", the unit can now be programmed and tested.

 To exit from the main menu press , if the unit is not operated for 1 minute, it will revert back to the "PLEASE RECORD" message (or "SD1+", fig 2).



Fig 1

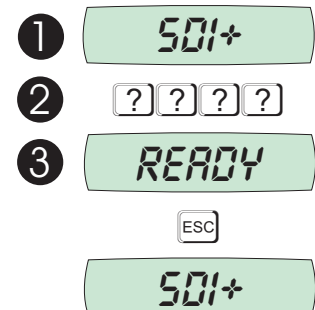
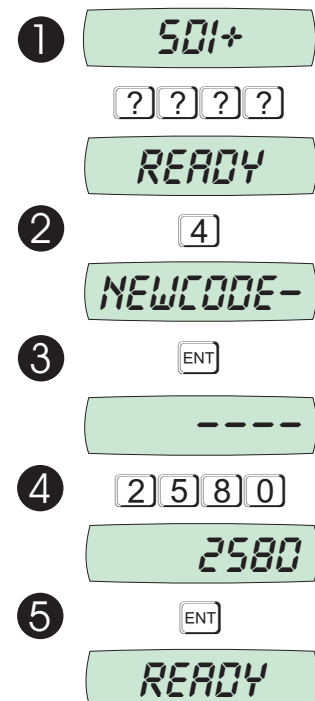

Fig 2

Changing Your Passcode

The SD1 + requires a passcode to be entered to allow access to the program menus, this passcode can also be used to abort the operation of the unit when triggered (see page 6). The passcode is normally four digits, but can be changed to six (see page 5). The default passcode is 1234 and can also be changed as required.

1. Ensure that the SD1 + is initialised and the display is showing "READY" (see page 4).
2. Press and the display will show "NEWCODE-".
3. Press and the display will show "----".
4. Enter your new passcode e.g. 2580.
5. Press to accept the new code and return to "READY".



Changing Your Passcode Type

The SD1+ requires a passcode to be entered to allow access to the program menus. This passcode is normally 4 digits (**4, CODE**), but can be changed to 6 digits (**6, CODE**). The default user passcode is 1234. If the passcode is changed from 4 to 6 digits, the last two digits of the code will default to (00) i.e. 1234 will now become 1234 00.

1. Ensure that the SD1+ is initialised and the display is showing "READY" (see page 4).
2. Press **[5]** and the display will show "C,TYPE-".
3. Press **[ENT]** and the display will show the code type option that is currently programmed i.e. "4, CODE".

 Scroll through the other 3 passcode options "4+E, CODE", "6, CODE" and "6+E, CODE", by pressing the **[B]** key.

 Note: Do not use the following passcode types: 4 digits followed by enter (4+E, CODE), or 6 digits followed by enter (6+E, CODE). These are reserved for future use

4. Press **[ENT]** to accept the option displayed and return to "READY".

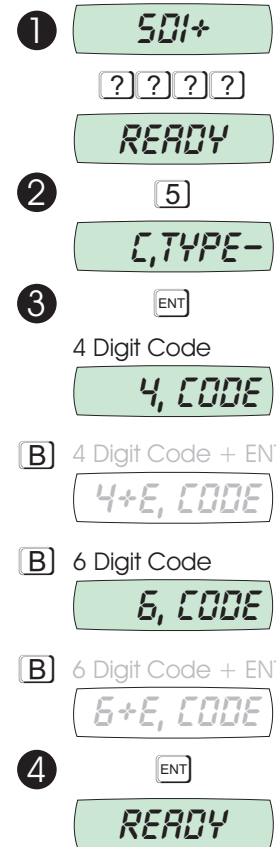

Programmable Output

The SD1+ has an output that can be programmed to activate under certain conditions. These conditions are: active when the SD1+ has been triggered (**ACTIVE**), active when the SD1+ has been acknowledged (**SUCCESS**) and, active when the SD1+ has dialled all numbers and has not been acknowledged (**FAILED**).

1. Ensure that the SD1+ is initialised and the display is showing "READY" (see page 4)".
2. Press **[6]** and the display will show "OUTPUT-".
3. Press **[ENT]** and the display will show the output type that is currently programmed i.e. "ACTIVE".

 If required, the other 2 output types "SUCCESS", and "FAILED" can be scrolled through by pressing the **[B]** key.

4. Press **[ENT]** to accept the option displayed and return to "READY".

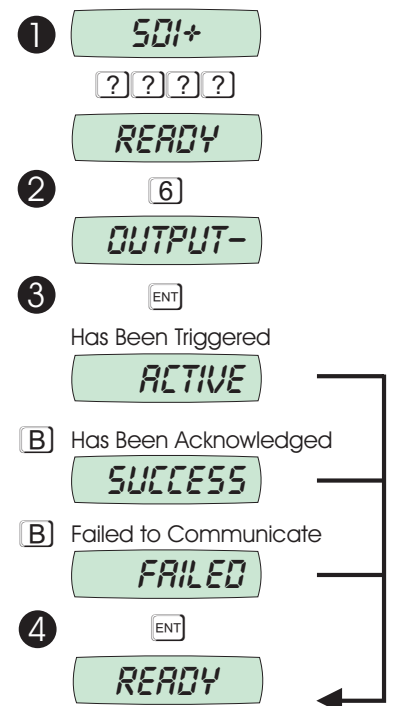

Call Routing

Messages A, B, C or D can be programmed so that they only report to certain telephone numbers i.e. Message A might report to telephone numbers 1, 3 & 4 but NOT to number 2 (A) 1-34).

1. Ensure that the SD1+ is initialised and the display is showing "READY" (see page 4).
2. Press [7] and the display will show "ROUTING-".

3. Press [ENT] and the display will show that message A is routed to telephone numbers 1, 2, 3 & 4 i.e. "A)1234".

 Press 1, 2, 3 or 4 to select or deselect the telephone numbers.

 If required, the other 3 options "B) 1234", "C) 1234" & "D) 1234", can be scrolled through by pressing the [B] key.

4. Press [ENT] to accept the option displayed and return to "READY".

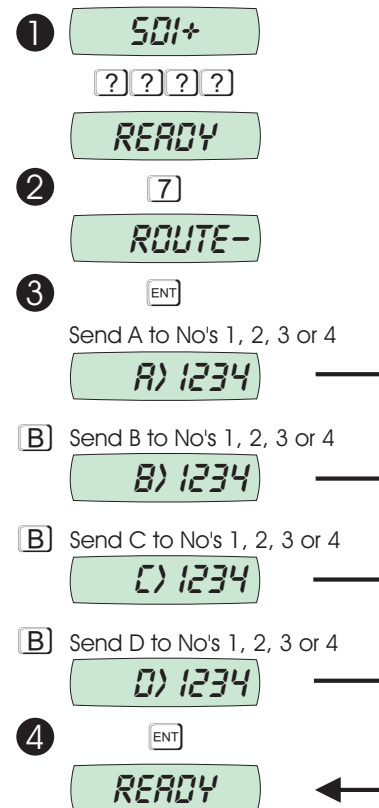

Abort Options

Occasionally you may trigger your alarm by accident and cause the SD1+ to send an unwanted call. When this happens the unit can be stopped, by applying a signal to the abort input on the SD1+ (INPUT), removing the trigger from the SD1+ (RESTORE) or, simply entering your user passcode (PASSCODE).

1. Ensure that the SD1+ is initialised and the display is showing "READY" (see page 4).

2. Press [8] and the display will show "ABORT-".

3. Press [ENT] and the display will show the abort option that is currently programmed i.e. "NONE".

 If required, the other 3 abort options "INPUT", "RESTORE" and "PASSCODE", can be scrolled through by pressing the [B] key.

 If the abort option is set for anything other than "INPUT", then the abort input becomes trigger "D".

4. Press [ENT] to accept the option displayed and return to "READY".

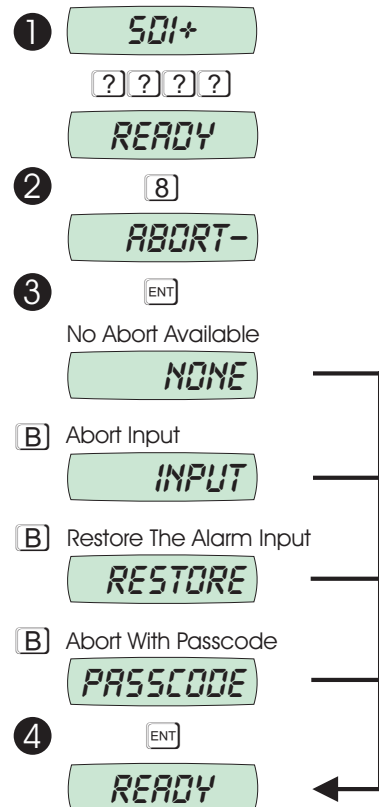

Viewing The Last Call Log

When a call is successfully acknowledged, the SD1+ stores the event in a "Last Call Log".

The log may then be viewed as follows:

1. Ensure that the SD1+ is initialised and the display is showing "READY" (see page 4).
2. Press **[9]** and the display will show "VIEWLOG-".
3. Press **[ENT]** and the display will show the Last Call Log i.e. "BLANK" if the log is empty, or "A) --3-" (Alarm on trigger input A acknowledged by recipient 3). If the display shows "A) ----" then none of the calls were acknowledged.
4. Press **[ENT]** to accept the option displayed and return to "READY".

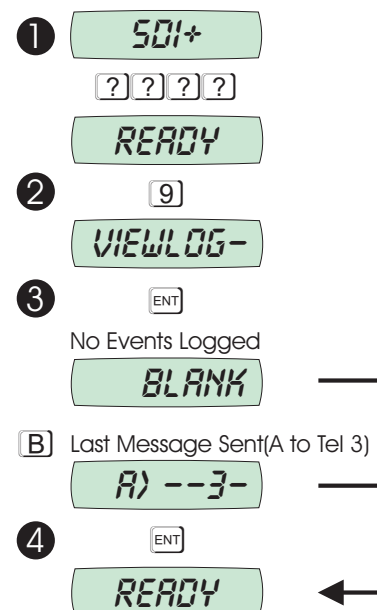

Acknowledgement Options

Once the SD1+ has made its call and delivered its message, it requires a signal to say that the message has been successfully received. This is done by the recipient pressing the number "8" button on their telephone. When the SD1+ has been acknowledged, it will shut down until it is triggered again. This option determines how many times the unit must be acknowledged before it shuts down. These options include: Any 1 person (ANY-1), Any 2 people (ANY-2), Any 3 people (ANY-3), All 4 people (ALL-4) or nobody at all (NO-ONE).

1. Ensure that the SD1+ is initialised and the display is showing "READY" (see page 4).
2. Press **[0]** and the display will show "CLEARBY-".
3. Press **[ENT]** and the display will show the acknowledgement option that is currently programmed i.e. "ANY-1".
 ☞ *If required, the other 4 acknowledgement options "ANY-2", "ANY-3", "ALL-4" and "NO-ONE", can be scrolled through by pressing the **[B]** key.*
4. Press **[ENT]** to accept the option displayed and return to "READY".

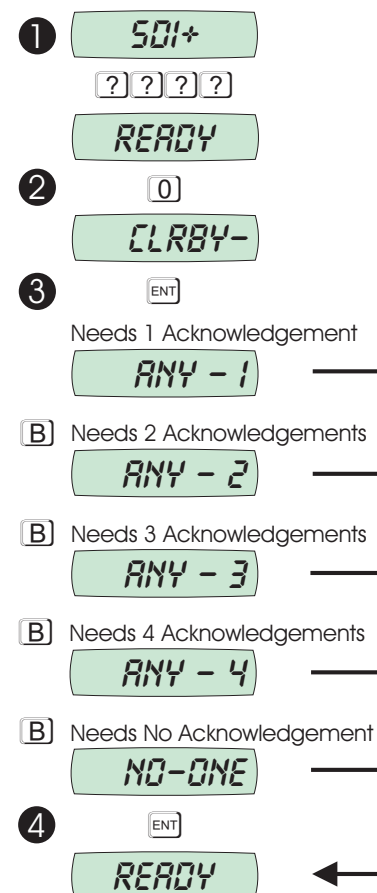

Programming: Telephone Numbers

The SD1+ stores up to four telephone numbers, with a maximum of 24 digits each. Permission from the person(s) being called must be obtained before storing their telephone number. The SD1+ must NOT be used to call the Police via the Emergency Services telephone numbers.

The following example shows how to program telephone number 1 as 0181 234 5678.

1. Ensure that the SD1+ is initialised and the display is showing "READY" (see page 4).

2. Press **ENT**, the unit will display "ENT 1-4 OR 0-C".

3. Press **1** for telephone number 1.

 1 to 4 will select numbers 1, 2, 3 or 4.

 0 to D selects phrases 0, A, B, C or D (see page 12).

4. The display will alternate between telephone No. 1 and the current number (Blank if it has not been programmed).

 If a telephone number is already programmed, this may be deleted by pressing the **A** key.

5. Type in the first phone number 0181 234 5678.

6. If a mistake is made whilst entering the number, press **A** to move the cursor back, re-enter the digit and press **C**.

 Pressing **C** will move the cursor forward again.

7. Finish typing in the telephone number and press **ENT**.

8. Repeat for telephone number 2, 3 & 4 as required.

9. When finished, press **ESC** to return to the ready prompt.

 In order for the SD1+ to comply with BABT regulations, the unit must NOT have any telephone numbers programmed the same.

 The SD1+ must NOT be used to call the Police via the Emergency Services telephone numbers.

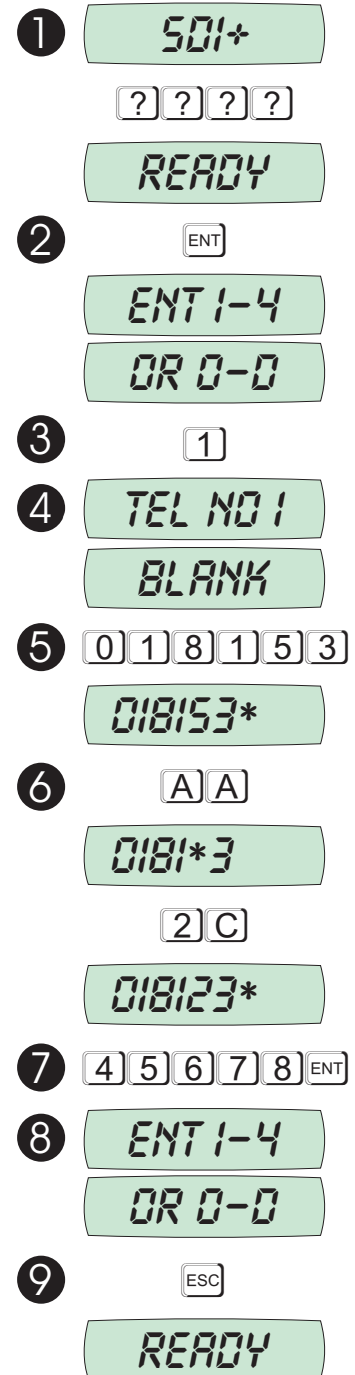

Forcing The SD1+ to Tone / Pulse Dial

Pulse Dialling: This is the older format and is sometimes referred to as Loop Disconnect/LD. **Tone Dialling:** This is the modern format and sometimes referred to as Multiple Frequency/MF. Any or all of the telephone numbers can be selected to override the automatic format selection and be forced into dialling the number in one of the above formats if required.

Before entering the telephone number 0181 234 5678 in the example below, press the **[B]** key to select "Pulse Dialling" (**P***) or press the **[C]** key to select "Tone Dialling" (**T**).

1. Ensure that the SD1+ is initialised and the display is showing "READY" (see page 4).

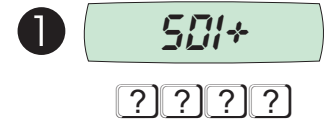

2. Press **[ENT]** and the unit will display "ENT 1-4 OR 0-C".

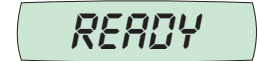

3. Press **[1]** for telephone number 1.

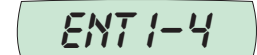

[1] 1 to 4 will select numbers 1, 2, 3 or 4.

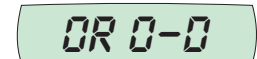

[0] 0 to D selects phrases 0, A, B, C or D (see page 12).



4. The display will alternate between telephone No. 1 and the current number (Blank if it has not been programmed).

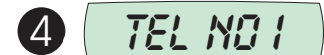

[A] If a telephone number is already programmed, this may be deleted by pressing the **[A]** key.

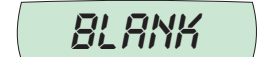

5. Press the **[B]** key once to select "Pulse Dialling" (**P***).



[C] Pressing the **[C]** key will select "Tone Dialling" (**T**).

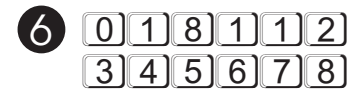

6. Type in the first phone number 0181 234 5678 and press **[ENT]**.

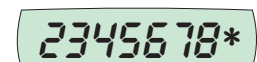

7. Repeat for telephone number 2, 3 & 4 as required.



8. When finished, press **[ESC]** to return to the ready prompt.

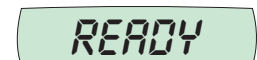

[Hand icon] If the SD1+ is NOT forced to pulse or tone dial, it will automatically select the correct dialling format.

Programming a Pause into the Telephone Number

If the SD1+ is connected to an internal PABX telephone exchange, a prefix digit i.e. 9 is normally required before an outside line can be obtained. Some exchanges also require a pause after this digit before dialling the telephone number. If required one or more 3 second pauses can be inserted after the prefix digit.

Before entering the telephone number 0181 234 5678 in the example below, press **[9]** for the dial out prefix, then press the **[B]** key three times to select a 3 second Pause.

1. Ensure that the SD1+ is initialised and the display is showing "READY" (see page 4).

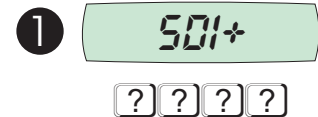

2. Press **[ENT]** and the unit will display "ENT 1-4 OR 0-C".



3. Press **[1]** for telephone number 1.



1 to 4 will select telephone numbers 1, 2, 3 or 4.



0 to D selects phrases 0, A, B, C or D (see page 12).

4. The display will alternate between telephone No. 1 and the current number (Blank if it has not been programmed).

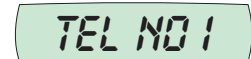

If a telephone number is already programmed, this may be deleted by pressing the **[A]** key.

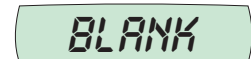

5. Press **[9]** (or your own prefix), and then **[B]** three times to select a pause, then press **[C]** to move the cursor forward again.

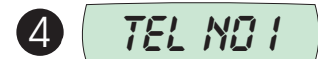

A pause is displayed as a comma (,).

6. The SD1+ will now show 9, (or your own prefix) on the display.

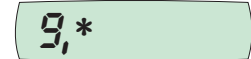

7. Type in the first phone number 0181 234 5678 and press **[ENT]**.

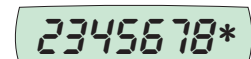
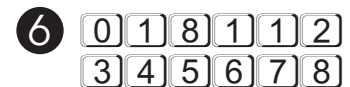

8. Repeat for telephone number 2, 3 & 4 as required.



9. When finished, press **[ESC]** to return to the ready prompt.



The pause option (,) will cause the SD1+ to wait 3 seconds before dialling the rest of the telephone number. Programming two (,,) or three (,,,) pause options will cause the SD1+ to pause 6 or 9 seconds.

Programming a Pager Number

When dialling a pager SD1 + may have to wait before sending the message. To insert a pause enter "M" after the pager number. When the call is answered, the unit can send the message as normal or precede it with a "star" or "hash". This is achieved by programming (M+NONE), (M+STAR) or (M+HASH) respectively. The pager message is ALWAYS terminated with a "hash".

Note: Each pager service has its own requirements for pauses, star and hash. You may have to experiment to find the correct combination for the service you are using.

After entering the pager number 0832 345678 in the example below, press [B] four times for the pager prefix "M", then [C] and enter the paging message i.e. 333, then press [ENT].

1. Ensure that the SD1 + is initialised and the display is showing "READY" (see page 4).
2. Press [ENT] and the unit will display "ENT 1-4 OR 0-0".
3. Press [1] for telephone number 1.

 1 to 4 will select telephone numbers 1, 2, 3 or 4.

 0 to D selects phrases 0, A, B, C or D (see page 12).

4. The display will alternate between telephone No. 1 and the current number (Blank if it has not been programmed).

 If a telephone number is already programmed, this may be deleted by pressing the [A] key.

5. Type in the pager number e.g. 0832 345678.

6. Press [B] four times to select the pager option (M), then press [C].

7. Type in the paging message i.e. 333 for alarm, then press [ENT].

 Anything entered after the "M", is used as the message.

 A digit relating to the input is also sent e.g. 1 = Trigger A.

 If the display shows "Phones" then press [B].

8. The display shows how the message is sent "M+NONE".

 If required, the other 2 options "M+STAR" and "M+HASH", can be scrolled through by pressing the [B] key.

9. Repeat for telephone number 2, 3 & 4 as required.

10. When finished, press [ESC] to return to the ready prompt.

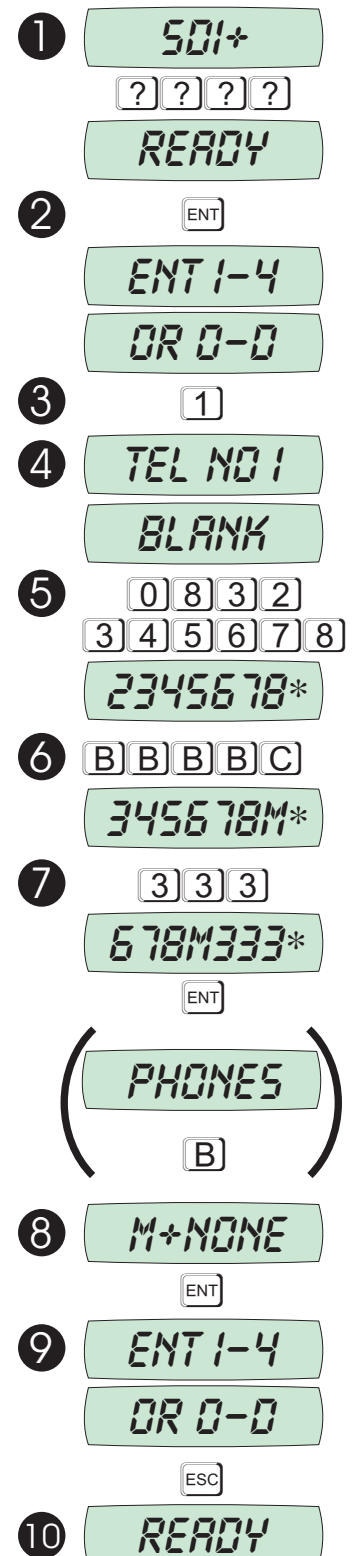

Recording Messages

The SD1+ can record up to four phrases A, B, C, D and a common phrase 0. These phrases can be up to forty seconds in total. The five phrases are used to form four messages A, B, C and D. Phrase 0 is normally used to store the name and address of the premises, whereas phrases A, B, C or D are used to store the type of alarm condition. It is also advisable to include the instruction to press the number "8" button on the telephone, at the end of the message e.g.

- Phrase 0: "This Is Mr Smith, at 10 The Strand, East Fincham"
- Phrase A: "The alarm has been activated, please press eight to acknowledge this call".

1. Ensure that the SD1+ is initialised and the display is showing "READY" (see page 4).

2. Press **ENT** and the unit will display "ENT 1-4 OR 0-0".

3. Press **0** for phrase 0.

 0 to D will select phrases 0, A, B, C or D.

 1 to 4 selects numbers 1, 2, 3 or 4 (see pages 8-11).

4. The display will show "RECORD PHRASE 0".

 Stand back about 6-8 inches from the unit.

 Before you record phrases, it is advisable to prepare them by writing them down first.

5. When ready, press the **ENT** key to start recording, and speak clearly into the unit.

 The display will show the remaining recording time.

 When re-recording a phrase, if the duration of the old phrase was previously 10 seconds, then the new phrase must be the same length.

6. To end recording at any time press **ESC**.

 The unit will also stop recording when the time runs out.

7. Repeat for phrases A, B, C & D as required.

8. When finished, press **ESC** to return to the ready prompt.

1 **SD1+**

? ? ? ?

READY

2 **ENT**

ENT 1-4

OR 0-0

3 **0**

4 **RECORD**

PHRASE 0

5 **ENT**

REC - 40

This is Mr Smith,
at 10 The Strand,
East Fincham.



REC - 32

6 **ESC**

7 **ENT 1-4**

OR 0-0

8 **ESC**

READY

Deleting Phrases & Telephone Numbers

If new phrases need to be recorded or new telephone numbers need to be programmed into the unit, the old ones will have to be deleted, this option will allow you to perform either of these actions.

1. Ensure that the SD1+ is initialised and the display is showing "READY" (see page 4).
2. Press **[ENT]** and the display will show "ENT 1-4 OR 0-0".
3. Press **[ENT]** and the display will show "ERASE-".
4. Press **[B]** and the display will show "SPEECH".
 If required, the other delete option "PHONES", can be scrolled to by pressing the **[B]** key.
5. Press **[ENT]** to accept the option displayed and return to "READY"

[Hand icon] If required, the telephone numbers can also be deleted individually when in the telephone number programming, (pages 8-10).

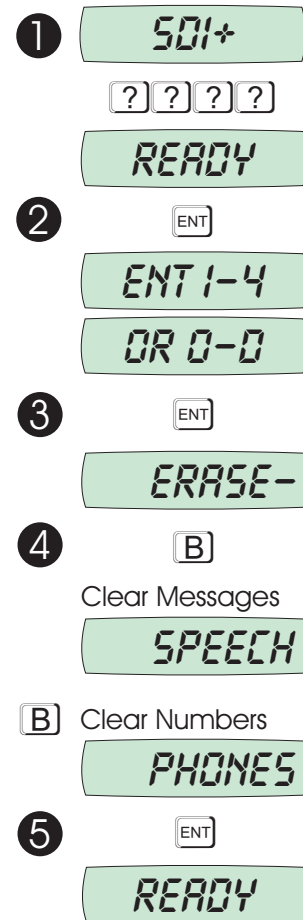

Testing the SD1 +: Call Acknowledgement Procedure

If the unit has been triggered or a test call has been sent, you must ensure that the recipient of the call is aware of the call acknowledgement procedure, so that they can successfully shut down the SD1 + and prevent it from dialling them again.

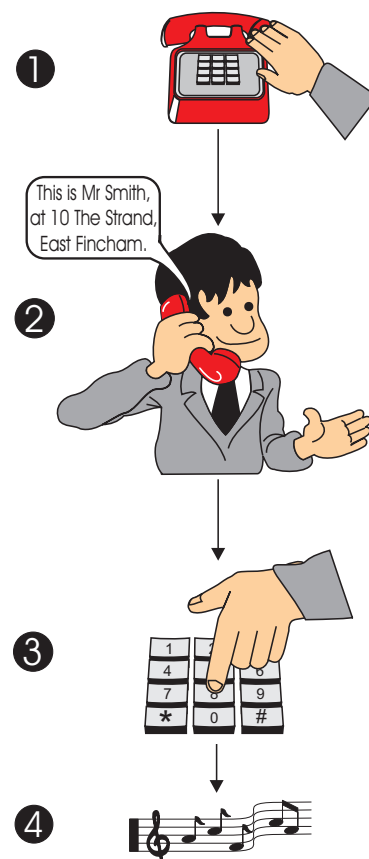

1. When the recipient's telephone rings, they should answer the call as they would any normal call.
2. The SD1 + will then play the message that corresponds to the trigger it has received, (normally the name and address of the premises followed by the relevant alarm message).
3. After the message, a tone is heard, the recipient should now press the "8" button on the telephone to acknowledge the call.
 -  **Pressing the number "8" button on the telephone at any point during the message, will also shut the unit down.**
4. If done correctly, an acknowledgement "tune" will be heard.
5. The recipient can then take the necessary action.



Playing Back Messages

Once the phrases have been recorded it is possible to play them back through the built in loudspeaker.

This example shows how to play back "Message A" (Phrase 0 + A):

1. Ensure that the SD1 + is initialised and the display is showing "READY" (see page 4).
2. Press **[A]** and the display will show "1-4 / ENT TO SEND".
 -  **Pressing **[B]**, **[C]** or **[D]** will select message B, C or D.**
3. After a 5 second delay the message is played.
4. Pressing **[ESC]** at any point during the message will abort the playback and return the unit to the "READY" prompt.
 -  **Repeat for message B, C or D, as required.**

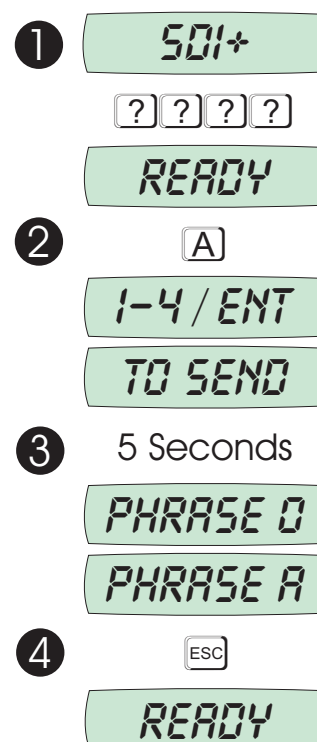

Sending A Test Call

It is possible to test that each message plays to each telephone number e.g. you may want to test that "Message A" plays to telephone number 1 or "Message B" to telephone number 3 etc.

Before sending a test call, make sure the person being called is familiar with the acknowledgement procedure. This will ensure that the SD1+ is successfully cleared down.

The following example shows how to send "Message A" to telephone number 1:

1. Ensure that the SD1+ is initialised and the display is showing "READY" (see page 4).

2. Press **[A]** and the display will show "1-4 / ENT TO SEND".

 Pressing **[B]** **[C]** or **[D]** will select message B, C or D.

3. Press **[1]**, to send message A to Telephone number 1.

 Pressing **[ENT]** at this point will send the message to all programmed telephone numbers.

 After the SD1+ has dialled out, it will attempt to detect a ringing signal. If this signal is detected, the display will show "RINGING". However, if this signal is not detected within 5 seconds, the unit will automatically start to play its message.

 The unit will then play phrase 0 (Name & Address) followed by phrase A (e.g. Fire Alarm). At the end of the message, the person receiving the call should carry out the call acknowledgement procedure (see page 14).

 If the call is successfully acknowledged the display will show "SENT OK". If the person receiving the call fails to acknowledge it on the first attempt the unit will repeat the message four times, giving them the opportunity to acknowledge the call at the end of each message. However if at the end of the last attempt they still fail to acknowledge the call the display will show "NO REPLY" and the unit will shut down.

4. Pressing **[ESC]** at any time will abort the test call and return the unit to the "READY" prompt.

 Repeat for message B, C or D, as required.

 Repeat for other test call combinations as required.

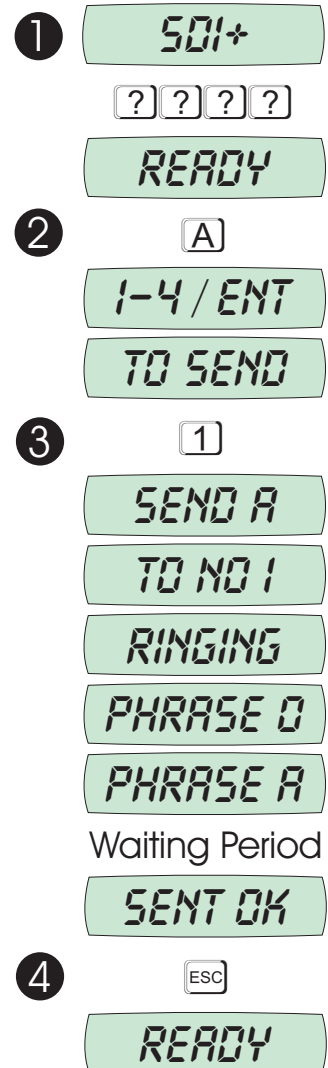

General: Three Way Calling

Three Way Calling is a feature that is available from BT Network Services. For the SD1+ to take advantage of this facility, the telephone line must have this service enabled (contact BT for details).

When the SD1+ is triggered, the unit checks for "dial tone", if no dial tone is detected i.e. another telephone is "Off Hook" or there is an incoming call. The unit then sends a "Recall" signal, which is detected by the exchange as a request for a new line. With a new line available, the SD1+ then attempts to dial out.

 **If the SD1+ is connected to an older pulse dial exchange, the numbers being dialled must be selected to pulse dial (see page 9). This will also disable the three way calling facility as this is not available on the older exchanges.**

Display Messages

<p>PLEASE RECORD</p>	<p>When the unit is first powered up, a factory restart is required (page 4). The SD1+ will then have a completely blank memory (no phone numbers or messages programmed), program these as required. If the unit is showing this display, and a factory restart has not been carried out, contact your installation company for further advice.</p>
<p>SD1+</p>	<p>This is the normal standby display of the SD1+ speech dialler. The unit will display this message whilst it is doing nothing AND whilst it is dialling out after it has been triggered.</p>
<p>RINGING</p>	<p>The SD1+ has detected a ringing signal. <i>This display will only be seen during a test call and NOT an activation.</i></p>
<p>ENGAGED</p>	<p>The recipient may already be on another call, wait until they have finished the call and try again. <i>This display will only be seen during a test call and NOT an activation.</i></p>
<p>UNOBTAIN</p>	<p>The SD1+ has detected an Unobtainable or Special Information Tone. Check the number and try again. <i>This display will only be seen during a test call and NOT an activation.</i></p>
<p>SENT OK</p>	<p>The SD1+ dialled out, sent the message and was acknowledged correctly by the recipient. <i>This display will only be seen during a test call and NOT an activation.</i></p>
<p>NO REPLY</p>	<p>The call was not answered or acknowledged by the recipient. <i>This display will only be seen during a test call and NOT an activation.</i></p>
<p>PAGED</p>	<p>If the SD1+ is programmed to dial a pager number, this message will be displayed when the pager message is sent. <i>This display will only be seen during a test call and NOT an activation.</i></p>
<p>ABORTED</p>	<p>The SD1+ was aborted by a user passcode whilst it was attempting to dial out following an activation. <i>This display will only be seen following an activation.</i></p>

Problem

The recipient has acknowledged the call but the SD1+ continues to dial the second, third or fourth number.

Cause

The "Call Acknowledgement" option is set to cleared by "ANY-2" or "ANY-3" or "ALL-4" (page 7).

Action

Check the option is set to the required setting.

Problem

The unit will not dial the telephone number that is programmed into the unit.

Cause

Number incorrectly dialled.

Action

Check the telephone number you are calling has been entered correctly.

Cause 2

The SD1+ is dialling out through an internal telephone exchange (PABX), that requires a pause after the initial "9".

Action 2

Make sure you have programmed a pause into the phone number, after the "9" (page 10).

Cause 3

The SD1+ is wired to an exchange, that needs a special button pressed to select a line.

Action 3

The unit cannot be used with this type of exchange. Connect it to a standard BT line.

Problem

The unit is triggered from the Control Panel but the display shows "SD1+" all the time.

Cause

The SD1+ doesn't display anything except for "SD1+" whilst it is triggered.

Action

To see the status of the SD1+ when triggered, use the "Test Call" option (page 15).

Problem

The recipient of the call can't acknowledge the unit by pressing the number "8" button.

Cause

Incompatible telephone.

Action

Call the recipient and ask them to press the number "8" button on their telephone. If you hear anything other than a tone, the telephone is not capable of acknowledging the SD1+. This may be overcome by using a tone pad to simulate the dialling tones. Contact your installation company for details.

Problem

I am pressing the  key for 6 seconds, but I cannot get to the "READY" prompt and the display still shows "PLEASE RECORD" or "SD1+".

Cause

The SD1+ requires a 4 digit passcode to enable you to gain access to the program menu's.

Action

Enter your user passcode (page 4).

Quick Reference: Dialler Options.

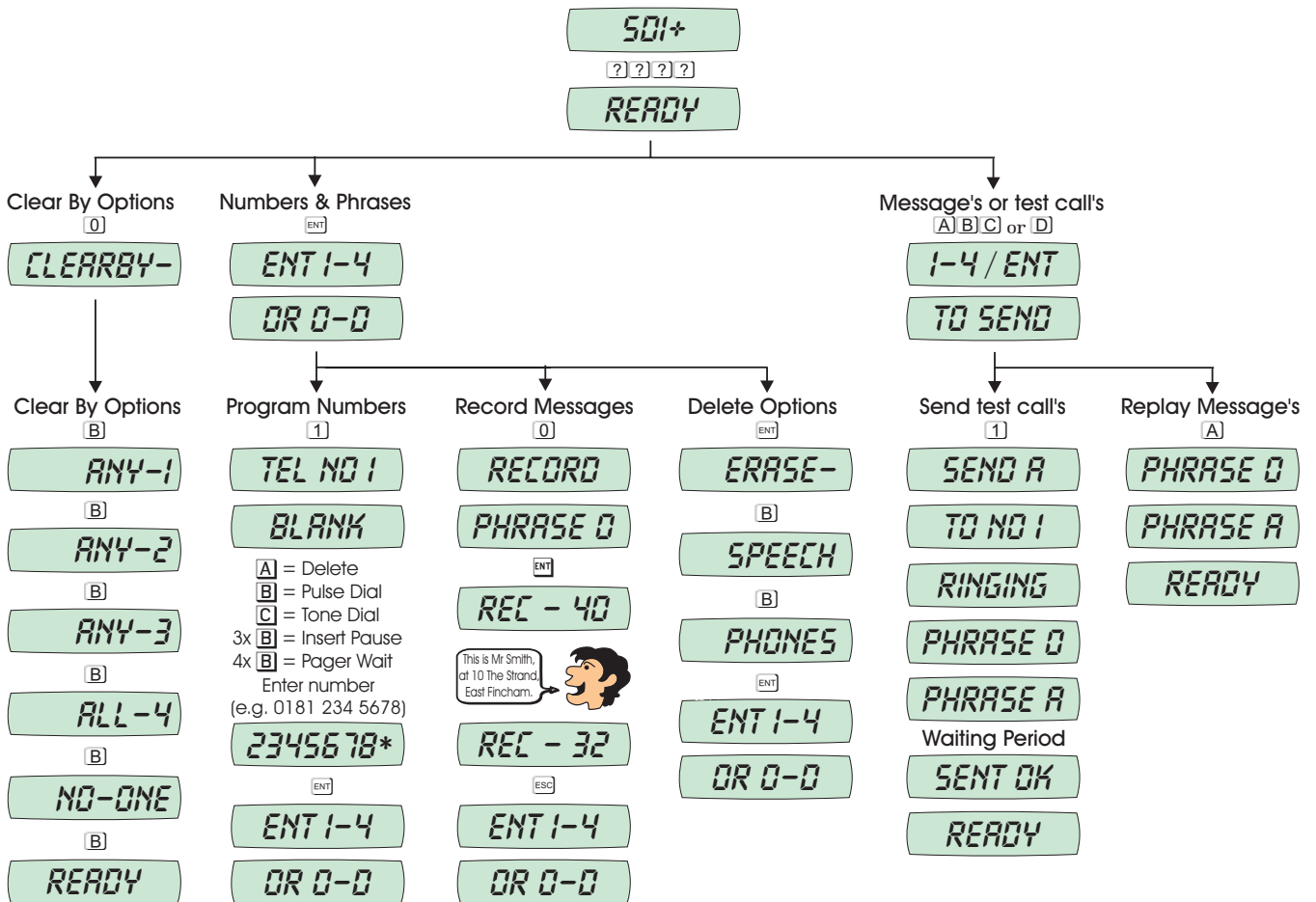

Quick Reference: Advanced Options.

