

Please read these instructions carefully before you start the installation

## Features

- LCD display showing text in any of 8 different languages
- 6 Trigger Inputs
- 4 Outputs
- 9 programmable phone numbers for each trigger
- Different 10 second recordable message or 32 digit SMS sent for each trigger
- Select whether a Voice Message, an SMS, or both Voice Message and SMS are sent to each of the phone numbers and whether all or just some phone numbers are contacted on each of the 6 triggers
- Built in memory for telephone numbers and programmed settings
- Inputs can be programmed as instant or “double knock”
- Programmable dial-out delay on trigger activation
- Outputs can be programmed as User activated only or User activated plus Trigger/Event activated
- Outputs can be programmed as either toggle latching or momentary
- Users can activate outputs remotely via dial-in or locally via Dialer keypad
- Built in Siren
- Built in Microphone plus terminals for remote Microphone
- 4 Digit programmable password for programming and dial-in
- Built-in “Listen-in”. Open up either after voice message received or by dial in
- Programmable as Silent Alarm (dial only) or Audible (siren + dialer)
- Cancel Message and Alarm at remote telephone using \* Key or cancel Message only using # Key
- Programmable daily/weekly/monthly test message (Voice or SMS) + Dial in to initiate instant test message
- Network Provider Field Strength Indication (via Dialer Display or SMS from Dialer)
- Trigger input runaway prevention - Ability to limit number of dial-outs or SMS's to 50 in any 24 hour period
- Pay as you go SIM low credit indication via all incoming SMS's being automatically forwarded
- Tamper Switch
- Battery back-up either from the Panel to which Dialer is connected or optional 9V PP3 battery
- External Power Fail SMS sent (provided PP3 battery installed)
- All options Programmable via Keypad. Certain programming sections also programmable via text message
- Dialer can send SMS's giving it's essential programming details
- Turn on/off Dialer via Keypad or dial-in plus password

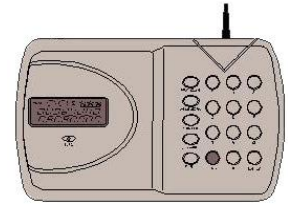

Manual Contents:	Page
Dialer Fitting Instructions	2
Connections on the Dialer	3
Programming Sections	4
Essential Programming	5
Advanced Programming	7
How to turn the Dialer On/Off	13
How to open up Listen-In	14
How to return to Factory Default Settings	14
How to turn the Outputs On/Off	15
How to initiate an immediate Test Call/SMS	15
Programming the Dialer by SMS	16
Other Useful Information	17
Trouble Shooting	19

- | Kit Contents:   |
|---|
| <ul style="list-style-type: none"><li>• 1 x GSM Auto Dialer</li><li>• 1 x Fixing Kit</li><li>• 1 x Installation and Programming Guide</li></ul> |

Current Cons:
60-70mA Standby
130-220mA Dial Out
90mA Internal Siren Operating
120-210mA Listen In Open
Excludes any Output Load
Operating Temp:
-20 to +70C

# Dialer Fitting Instructions

## Tools required:

- Small cross head screw driver & Large cross head screw driver
- Number 6 masonry drill bit
- Hammer drill
- Small hammer
- Pencil, ruler and spirit level

**Important:** before you install the Auto Dialer please take these into consideration.

1. Before you start to drill holes check for hidden wires and pipe work.
2. Keep the Auto Dialer out of reach of small children

## How to install the Auto Dialer

1. Remove the screw from the SIM card cover on the rear of the unit and keep safe.
2. Slide back the SIM card holder and insert SIM card with the cut corner at the top, close SIM holder sliding it back in to the lock position.
3. Replace SIM card cover and small cross head screw.
4. Connect the 12V power supply to terminals.(+12 and 0V) and, if required, install a 9V back up battery to the connector inside the battery compartment (if used with an alarm panel, then the alarm panel's back up battery would usually be the source for mains failure back up).
5. The Auto dialer will automatically start to search for the SIM card GSM network. The words "GSM Start" will appear in the display and a counting sequence from 1 to 5. If the GSM network is found, the display will change to "On GSM Ready". If the GSM network cannot be found, the display will read "No Signal". If this is the case, change the location of the Dialer or use an alternative provider's SIM card. If there is problem with the SIM card or it has not been installed correctly into the holder, the display will read "SIM Error". **Important.** If the SIM card is pin protected, the counting sequence will stop at 1 and the words "PIN" will appear in the display. You will need to enter the SIM cards pin code at this point in order to proceed further.
6. Press 1 2 3 4 > ESC to turn the Dialer OFF (Dialer turns on automatically when power first connected. The Dialer must be Off to enable any programming). The display will now read "Off GSM Ready".
7. Mark and drill two holes on a horizontal line 160mm apart.
8. Insert the masonry plugs; screw the two fixing screws in the plugs leaving 2mm protruding.
9. Run cable from the Dialer to the Alarm Panel (or whatever panel/device you are connecting to). Note Figs 1 and 2 "Connections on the Auto Dialer" below. The number of cable strands will be determined by the number of triggers you require and whether you want the Dialer tamper switch to be active.
10. If required, connect the Dialer's two tamper terminals to the N.C. tamper inputs on the Alarm Panel. Activation of the Dialer's rear tamper switch will then cause the Panel to go into alarm. If you require a voice/text message on tamper activation, connect the Panel's tamper output to one of the Dialer's trigger inputs.
11. If required, run a cable from the Dialer's outputs to the devices you wish to activate
12. If required, run cables from the panel's microphone terminals to a remote microphone for better "listen-in".
13. If required, unscrew and replace the existing antenna with a remote antenna & cable.
14. Place the Auto Dialer onto the wall, making sure the tamper switch is pressed in.
15. Press 1 2 3 4 > ENTER to turn the Dialer On after programming has been complete

## How to test the Dialer's Signal Strength

Whilst the Dialer is in the OFF mode (enter 4 digit code, default 1234 + ESC key), press ENTER to display the Network reception quality on the LCD display. A number between 0 and 7 will appear. The strongest reception quality is 7. **The dialer should only be installed in a location where the signal strength display shows 2 or above.** Move the dialer to a different location if the number is 1 or below. You can continue to check the Network reception strength at any time provided the Dialer is in the OFF mode.

Note that you can also check signal strength by calling the Dialer and entering your code + 7 once it has answered. The Dialer will then send an SMS with current signal strength to Phone No 1 as programmed.

# Connections on the Auto Dialer

The Trigger terminals are for connection to a switched negative output of an Alarm System's Bell or Siren (Fig 1 below). If such switched negative triggers are not available, connect the trigger inputs to a N.O. (normally open) relay output with the relay common to 0V (Fig 2).

The Output terminals are all switched negative (max 100mA). Connect the connected device's positive pin to the 12V terminal and the device's negative pin to the respective output terminal (O/P1, O/P2, O/P3 or O/P4)

The Power terminals are for connection to a 12V power supply, either directly to an Alarm Control Panel's 12V supply or else via a regulated 12V 500mA mains power adaptor.

The MIC terminals are for connection to an optional external microphone for improved "listen-in"

Important: The Tamper terminals are for connection to the N.C. (normally closed) tamper inputs on an Alarm Control Panel. If they are not being used, please fit a loop of cable as shown

Fig 1

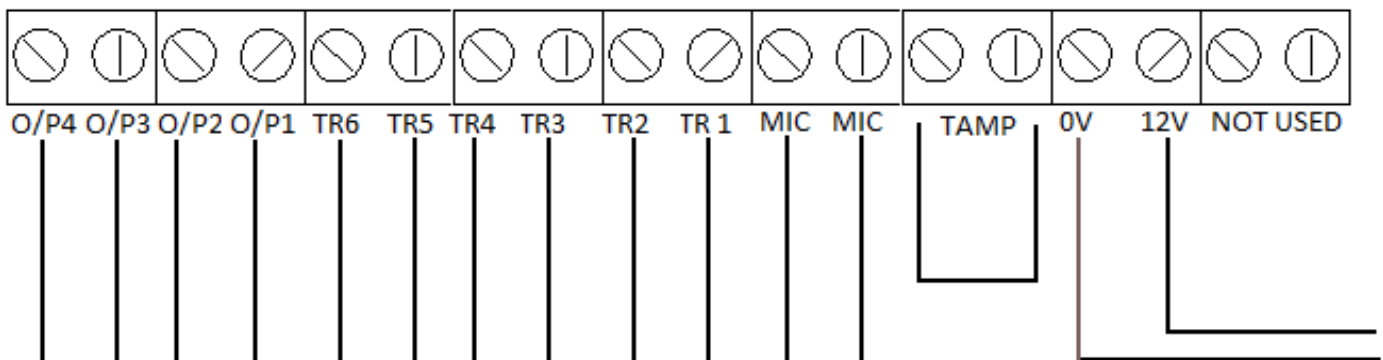

**Trigger Inputs are switched negative (-), they will not operate off a switched ground**

Fig 2

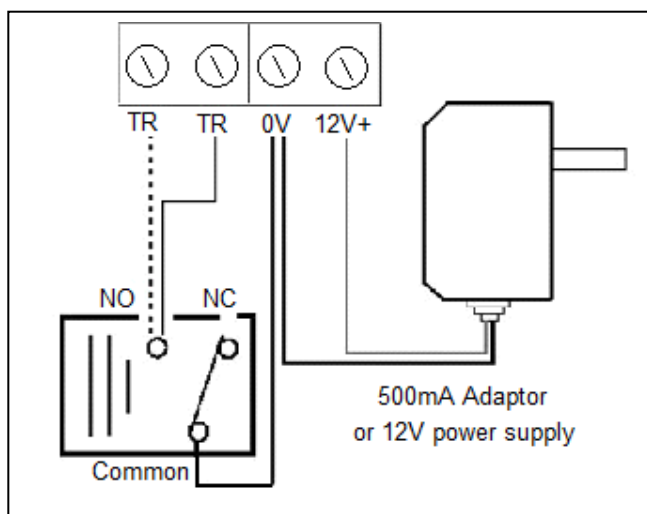

## Programming Sections

**NOTE:** The System must be in the OFF Mode for Programming. Since the Dialer will automatically turn itself on when power is first connected or re-connected, you need to turn the Dialer OFF (enter the default code 1234 and then press ESC Key) before you can start programming as below:

**NOTE:** Only Programming Sct 3, plus the Record, Play and Password Sections are essential to program. For most applications, other sections can be left in their default settings. Programming Sct 6 can also be left in its default setting (activation of a trigger will mean ALL Tel numbers that have been programmed into the dialer are dialled) unless you need to send the Trigger 1 message to different numbers than those for Trigger 2 etc. You must record at least One Voice Message and program at least One phone number into section 3 for the Dialer to work.

SECTION	
1	Select Audible or Silent Alarm on trigger (Default – Silent Alarm)
2	Duration of Audible Alarm on trigger (Default – 3 Minutes)
3	Add/Delete Phone Numbers that are dialled out/SMS's sent to on trigger (Default – Memory Empty)
4	Select a Delay between Trigger and Dial-out (Default – No Delay, Instant Dial Out)
5	Select a Delay between the Dialer being turned On/Armed & becoming active (Default – No Delay)
6	Assign the 9 dial-out Telephone Numbers to triggers 1, 2, 3, 4, 5, 6 (Default – <u>ALL</u> Telephone Numbers assigned to <u>ALL</u> triggers)
7	Select an Audible Arm Delay sound (Default – No sound)
8 (1)	Select whether each Output is momentary or Toggle Latching (Default – All are momentary)
8 (2)	Select the time of the momentary Output (Default – All are 5 seconds)
8 (3)	Select whether an Output is Input Trigger/Event Activated as well as User Activated (Default – All Outputs are User Activated only)
8 (4)	Select Audible or Silent Keypad Stroke (Default – Audible, “Beep” heard each time a key is pressed on the Keypad)
9	Create or Delete an SMS to be sent instead of Voice messages (Default – Empty)
0 (1)	Select whether a Voice message or SMS is sent on activation of each Trigger (Default – Voice messages sent on activation of each trigger)
0 (2)	Regular Test message sent to avoid Pay-As-You-Go SIM card de-activation (Default – Off)
0 (3)	Show the SIM's IMEI Code
0 (4)	Select from one of 8 different languages (Default – English)
0 (5)	Limit the number of SMS's or Voice calls made to 50 in any 24-hour period (Default – No Limit)
0 (6)	Forward any incoming Dialer SMS's to Telephone Number 1 as programmed (Default – No SMS Forwarding)
0 (7)	Select whether the Trigger Inputs are instant or double knock (Default – Instant)
0 (8)	Select whether an individual Trigger Input is Normally Open or Normally Closed (Default – Normally Open)
0 (9)	Select whether an SMS is sent to Tel no 1 on input power failure (Default – No SMS sent)
RECORD	Record the nine different voice messages
PLAY	Play back the nine voice messages
PASSWORD	Change the Default Password of 1234
DEFAULT	Return the Dialer to its Default Settings

All Programming must be done when the Dialer is in the “OFF” mode (1234 ESC)

## How to Record the Voice Messages:

**Quick guide:** Press 1 2 3 4 > RECORD > 1 > ENTER, Record message now.

**(Note: 1= message for Trigger 1, 2= message for Trigger 2 etc, 0 = Test Message, if required. If you wish to receive a periodic or instant voice Test message instead of SMS Test message, 0 needs to be programmed)**

1. Key in the four digit user PASSWORD code (factory default 1234).
2. Press RECORD.
3. Press 1 (to record as the message for Trigger 1) or 2 (to record as the message for Trigger 2) or 0 (to record the Test Message). If a periodic Test Message is required, it then needs to be programmed as active as a daily, weekly or monthly test call in Programming section 0 – subsection 2.
4. Press ENTER to start recording the message. You now have 10 seconds to record your message
5. Press ENTER to stop the recording, or wait for the 10 seconds to end.

## How to Play Back the Voice Messages:

**Quick guide:** Press 1 2 3 4 > PLAY > 1 > ENTER to play back the recorded messages.

**(Note: 1 = The first message, 2 = The second message, 0 = Test Message)**

## How to Change the User PASSWORD:

(Factory Default 1234)

**Quick guide:** Press 1234 > PASSWORD > New Code > Reconfirm New Code

1. Key in the four digit user <PASSWORD> code. Factory default 1234.
2. Press PASSWORD.
3. The LCD will display “PASSWORD”
4. Key in your new four digit code and press ENTER
5. You have now changed to your new four digit password

**NOTE:** You can also program this section by sending an SMS to the Dialer. See “Further Programming by SMS” in “Advanced Programming”.

## How to Program Phone Numbers for the Dialer to call upon trigger – Section 3:

You can enter a maximum of 9 telephone numbers; each number can be a maximum of 32 digits.

**Quick guide:** Press 1 2 3 4 > PROGRAM > 3 > ENTER > 1 > ENTER > Telephone number > ENTER

1. Key in the four digit user PASSWORD code (factory default 1234).
2. Press PROGRAM > 3 > ENTER > “X”. The number “X” you press after the ENTER button selects the position in the sequence you want that tel number to be called (1=1st number called, 2=2nd number called).
3. Key in the first telephone number (max 32 digits)
4. Press ENTER to exit the programming mode.
5. Repeat the process until you have entered all the numbers you wish the Auto Dialer to call once it has been triggered (maximum 9 different numbers). You can repeat the same number/s if you wish.

**NOTE:** You can also program this section by sending an SMS to the Dialer. See “Programming by SMS” in “Advanced Programming”.

## How to Delete Phone Numbers – Section 3:

**Quick guide:** Press 1 2 3 4 > PROGRAM > 3 > ENTER > 1 > ENTER > DELETE > ENTER

1. Key in the four digit user Password code (factory default 1234).
2. Press PROGRAM > 3 > ENTER. Select the position for the telephone number you want to delete (1=1st number called, 2= 2nd number called) and press DELETE. The LCD display will show “DELETE ?” press ENTER to delete this number or ESC to keep the number and exit Programming.

## **How to Designate Telephone Numbers to TRIGs 1,2,3,4,5 and 6 + the Test Call – Section 6:**

(Factory Default – all numbers are called for each trigger input and the Test Call)

Only these selected Telephone Numbers will be called/SMS's sent to on activation of the respective trigger input.

**Quick guide: Press 1 2 3 4 > PROGRAM > 6 > ENTER > X > ENTER > N > ENTER**

1. Key in the four digit user PASSWORD code (factory default 1234)
2. Press PROGRAM > 6 > ENTER.
3. Press 1 (for TRIG 1), or press 2 (for TRIG 2) etc, press 0 for the Test Call Press ENTER
4. You will see numbers 123456789 illuminated in the Display. This indicates that all 9 telephone numbers (or as many as have been programmed into the dialer) will be called or sent an SMS on that trigger.
5. Press 1 - 9 to de-select that phone number from being dialled. You will now see a blank “-“ where that number was previously. Press ENTER to save the setting.
6. Repeat the process until you have designated all the numbers to each trigger. Remember that you can designate all 9 numbers to each trigger or only some to one and some to the other.

**IMPORTANT :** The numbers shown on the LCD display are the phone numbers assigned to that trigger or to the Test Call (see section 0 sub-section 2 to enable/disable the Test Call). Pressing buttons 1 to 9 will toggle the numbers on/off on 1-9 respectively. If a number is not shown, then it means that it will not be called.

Example: 

123 - - - 7- 9
----------------

 means that only tel numbers 1,2,3,7 and 9 will be dialled for that specific trigger.

**IMPORTANT:** Section 0 sub-section 1 selects whether each programmed telephone number to be called receives a voice message only, an SMS only or both a voice message and SMS (default voice only). It also selects whether a voice message, SMS or both is sent on the Test Call. Note that some network providers now require a voice message rather than data only to keep a pay as you go SIM card active.

**NOTE:** You can also program this section by sending an SMS to the Dialer. See “Further Programming by SMS” in “Advanced Programming”.

## **How to create an SMS message to for a Trigger Input and/or a Test Message – Section 9:**

(Default memory is empty)

**Quick guide: Press 1 2 3 4 > PROGRAM > 9 > ENTER > 1 > ENTER > MESSAGE > ENTER**

**(“1” = Trigger Input 1 – 6 or “0” = Test Message. “MESSAGE” = 32 Digit message including spaces)**

1. Key in the four digit user <PASSWORD> code. (Factory default 1234).
2. Press PROGRAM > 9 > ENTER

Display will show

SMS Mess
----------

Press 1 to program a message for Trigger Input 1, or 2 for input 2, or 0 to programme the Test message

The Display will now be blank. Use the keys 1-0 on the keypad to enter letters or pronunciation marks. Press each key continuously to obtain different letters as per a standard telephone keypad. Pressing the 0 key briefly moves the cursor to the right, pressing it twice creates an 0. That means:

1 = “ ! ” or “ , ” or “ . ” or “ 1 ”    2 = “ a ” or “ b ” or “ c ” or “ 2 ”    3 = “ d ” or “ e ” or “ f ” or “ 3 ”    etc. etc.

The cursor will move automatically to the next letter approximately 2 seconds after you have made your entry. To edit, Press the RECORD key to move the cursor right, Press the PLAY key to move the cursor left, Press the DELETE key to delete the letter over which the cursor is flashing. Press ENTER to save the text.

**NOTE:** You can also program this section by sending an SMS to the Dialer. See “Further Programming by SMS” later in “Advanced Programming”.

## **How to select whether a telephone number receives just a Voice Message, just an SMS or both a Voice Message and SMS – Section 0 (sub-section 1):**

(Default is that all telephone numbers receive a Voice Message only)

**Quick guide: Press 1 2 3 4 > PROGRAM > 0 > ENTER > 1 > ENTER > N > ENTER > 0 > ENTER**  
(N= Telephone Number 1,2,3,4,5,6,7,8 or 9    1= Voice, 0= SMS, 2=both Voice & SMS)

- 1) Key in the four digit user <PASSWORD> code. (Factory default 1234).
- 2) Press PROGRAM > 0 > ENTER > 1 > ENTER  
(Note, pressing 1 after “0” means you enter section 0, sub-section 1)

Display will show

Voice or SMS

Press 1 to program Telephone Number 1, 2 to program Telephone Number 2 etc.

Display will show

Voice or SMS 1  
Voice

Press 0 to select that telephone number to receive an SMS only or Press 2 to select that telephone number to receive an SMS and voice message. Press 1 to return to the input sending a voice message only. Where both voice messages and SMS are selected, the dialer will send all SMS's out first, then start dialing each number in sequence. Pressing # or \* buttons will cancel continued voice message dial out or pressing 9 will open up listen-in and cancel further dial out.

Press ENTER to save your selection

## **Advanced Programming**

### **How to Program the Auto Dialer to give a local Audible Alarm as well as sending a Voice Message – Section 1:**

(Default setting is Alarm OFF)

**Quick guide: Press 1 2 3 4 > PROGRAM > 1 > ENTER > 1 > ENTER (1=Audible, 0=Silent)**

1. Key in the four digit user <PASSWORD> code. (Factory default 1234).
2. Press PROGRAM > 1 > ENTER >

Display will show

Alarm Sound  
Silent

Press 1 to Change to Audible, Press 0 to return to Silent.    Press ENTER to save your selection

### **How to Set the Time the Audible local Alarm will sound on activation – Section 2:**

(Default is 3 mins)

**Quick guide: Press 1 2 3 4 > PROGRAM > 2 > ENTER > Time > ENTER (Alarm time is from 1M-99M.)**

1. Key in the four digit user <PASSWORD> code. (Factory default 1234).
2. Press PROGRAM > 2 > ENTER >

Display will show

Alarm Time  
5 Minutes

Press digits 1-9 to set the time in minutes between 1-99 that you wish the alarm to sound on activation. We recommend that you do not exceed a 20 min alarm duration. Press ENTER to save your selection.

## How to set Trigger Delay times – Section 4:

(Default is 0 seconds - instant)

Set trigger delay time between 0, 30 and 60 seconds: As a false alarm prevention feature, this is the delay between a trigger being activated and when the dialer starts to dial out. Default setting is 0 secs.

**Quick guide: Press 1 2 3 4 > PROGRAM > 4 > ENTER > N > ENTER (N=0 or 3 or 6)**

1. Key in the four digit user <PASSWORD> code. (Factory default 1234).
2. Press PROGRAM > 4 > ENTER >

Display will show

Trigger Delay  
Instant

Press 3 to Change to 30 seconds, Press 6 to change to 60 seconds, Press 0 to return to Instant  
Press ENTER to save your selection

## How to set Arm Delay times: – Section 5:

(Default set at 0 seconds, instant)

Set arm delay time between 0, 30 and 60 and 90 seconds: This is the delay between the dialer being armed or primed and the time the triggers are active or ON. Default setting is 0 seconds, or no arm delay. Note that if an arm delay time is programmed, then the ON symbol on the LCD display will flash throughout the programmed time delay period.

**Quick Guide Press 1 2 3 4 > PROGRAM > 5 > ENTER > N > ENTER (N=0 or 3 or 6)**

1. Key in the four digit user <PASSWORD> code. (Factory default 1234).
2. Press PROGRAM > 1 > ENTER >

Display will show

Exit Delay  
Instant

Press 3 to Change to 30 seconds, Press 6 to change to 60 seconds, Press 0 to return to Instant  
Press ENTER to save your selection

## How to set the Arm Delay Sound – Section 7:

(Default is silent)

Select whether you want an silent or audible sound on any arm delay (default is silent)

**Quick guide: Press 1 2 3 4 > PROGRAM > 7 > ENTER > 1 > ENTER (1=Audible, 0=Silent)**

1. Key in the four digit user <PASSWORD> code. (Factory default 1234).
2. Press PROGRAM > 7 > ENTER >

Display will show

Exit Delay Sound  
Silent

Press 1 to Change to Audible, Press 0 to return to Silent  
Press ENTER to save your selection

## How to select whether an Output is 5 second momentary (pulsed) or toggle latching (first activation latches output On, second activation turns it Off) – Section 8 (sub-section 1):

(Default setting is momentary)

**Quick guide: Press 1 2 3 4 > PROGRAM > 8 > ENTER > 1 > ENTER > N > ENTER > 1 > ENTER**

**(N= Output 1,2,3 or 4     0 = Timed, 1 = Latched)**

1. Key in the four digit user <PASSWORD> code. (Factory default 1234).
2. Press PROGRAM > 8 > ENTER > 1 > ENTER

(Note, pressing 1 after "8" means you enter section 8, sub-section 1)

Display will show

Output

Press 1 to program Output 1, press 2 to program Output 2 etc.

Display will show

Output 1  
Timed

Press 1 to Latching Toggles, Press 0 to return to Instant  
Press ENTER to save your selection



## How to select the time of a momentary output– Section 8 (sub-section 2):

(Default is 5 secs)

Quick guide: Press 1 2 3 4 > PROGRAM > 8 > ENTER > 2 > ENTER > Time > ENTER

(Time is any one or 2 digits between 1 – 99 = Output time from 1sec-99secs.)

1. Key in the four digit user <PASSWORD> code. (Factory default 1234).
2. Press PROGRAM > 8 > ENTER > 2 > ENTER

(Note, pressing 2 after “8” means you enter section 8, sub-section 2)

Display will show

Timed Pulse Time

Press digits 1-9 to create the time in seconds that you wish to select as the time for a pulsed momentary output to activate (between 1 – 99 seconds). Press ENTER to save your selection

Note that the Output time selected will be the same for ALL outputs selected as being pulsed momentary.

## How to select whether an Output is Event (Trigger activated) as well as User Activated – Section 8 (sub-section 3):

(Default is User Activated only)

Quick guide: Press 1 2 3 4 > PROGRAM > 8 > ENTER > 3 > ENTER > N> ENTER > 1 > ENTER

(N= Output 1, 2,3 or 4     0= User activated only, 1= User + Event/Trigger Activated.)

1. Key in the four digit user <PASSWORD> code. (Factory default 1234).
2. Press PROGRAM > 8 > ENTER > 3 > ENTER

(Note, pressing 3 after “8” means you enter section 8, sub-section 3)

Display will show

Output Type

Press 1 to program Output 1, press 2 to program Output 2 etc.

Display will show

Output Type     1  
User

Press 1 to select Output as activating on Trigger 1 (if selected, Output 1 will then activate on activation of Trigger 1, Repeat to program Output 2 activating on Trigger 2 etc.), Press 0 to return to User activation only.

Press ENTER to save your selection

## How to select whether a Keystroke is Audible or Silent – Section 8 (sub-section 4):

(Default is Audible) An Audible Keystroke means you will hear a “beep” each time to press a key on the keypad during programming etc.

Quick guide: Press 1 2 3 4 > PROGRAM > 8 > ENTER > 4 > ENTER

0= Silent, 1= Audible

1. Key in the four digit user <PASSWORD> code. (Factory default 1234).
2. Press PROGRAM > 8 > ENTER > 4 > ENTER

(Note, pressing 4 after “8” means you enter section 8, sub-section 4)

Display will show

Key Sound  
Audible

Press 0 to select a Keystroke as Silent, Press 1 to return to an Audible Keystroke. Press ENTER to save your selection.

## How to select whether the Dialer sends out a regular Test Call or SMS – Section 0 (sub-section 2):

(Default no Test Call or SMS)

**Quick guide: Press 1 2 3 4 > PROGRAM > 0 > ENTER > 2 > ENTER > 1**

**(1= Monthly, 2 = Weekly, 3 = Daily, 0= No Test Call)**

1. Key in the four digit user <PASSWORD> code. (Factory default 1234).
2. Press PROGRAM > 0> ENTER > 2 > ENTER

(Note, pressing 2 after “0” means you enter section 0, sub-section 2)

Display will show

Test Call  
No Test Call

Press 1 to select a monthly test call, 2 to select a weekly test call, 3 to select a daily test call, 0 to return to No test call.

If 1 is pressed:

Display will show

Test Call  
Monthly

Press ENTER to save your selection

**NOTE:** You can also program this section by sending an SMS to the Dialer. See “Further Programming by SMS” later in this manual.

**IMPORTANT:** Most PAY AS YOU GO SIM cards will be disabled after a certain period if they are inactive (this period varies according to the network provider). Therefore, to stop this from happening, please ensure a Test Call message (1234 + Record + 0) or a Test Call SMS (Programming Section 9) has been recorded/written and enable the regular test call feature as above. Section 6 selects the numbers to which you wish the test call to be sent to. Section 0 sub section 1 selects whether it is a voice message or SMS. Some service providers now require voice rather than data only to keep a pay as you go SIM card enabled.

## How to show the SIM card’s IMEI code – Section 0 (sub-section 3):

**Quick guide: Press 1 2 3 4 > PROGRAM > 0 > ENTER > 3 > ENTER**

1. Key in the four digit user <PASSWORD> code. (Factory default 1234).
2. Press PROGRAM > 0> ENTER > 3 > ENTER

(Note, pressing 3 after “0” means you enter section 0, sub-section 3)

Display will show

IMEI Code  
453218905632989

## How to select the language you wish to show in the LCD display – Section 0 (sub-section 4):

(Default English)

**Quick guide: Press 1 2 3 4 > PROGRAM > 0 > ENTER > 4 > ENTER > 1 > ENTER**

**(0= English, 1= French, 2 = Italian, 3 = Spanish, 4= German, 5= Portuguese, 6 = Dutch, 7= Swedish)**

1. Key in the four digit user <PASSWORD> code. (Factory default 1234).
2. Press PROGRAM > 0> ENTER > 4 > ENTER

(Note, pressing 4 after “0” means you enter section 0, sub-section 4)

Display will show

Language  
English

Press 1 to select French, 2 to select Italian, 3 to select Spanish, 4 to select German, 5 to select Portuguese, 6 to select Dutch, 7 to select Swedish or 0 to return to English

Display will show

Language  
Francais

Press ENTER to save your selection

**How to select whether, as an input “runaway” safety mechanism you wish to limit the number of calls the Dialer can make in any 24 HR period to 50 – Section 0 (sub-section 5):**

(Default: No Limit)

**Quick guide: Press 1 2 3 4 > PROGRAM > 0 > ENTER > 5 > ENTER > 1 > ENTER (0= No Limit, 1= Limit to 50)**

1. Key in the four digit user <PASSWORD> code. (Factory default 1234).
2. Press PROGRAM > 0> ENTER > 5 > ENTER

(Note, pressing 5 after “0” means you enter section 0, sub-section 5)

Display will show 

Limit to calls No Limit
----------------------------

Press 1 to select a limit to 50 calls or SMS’s in any 24 HR period or 0 to return to No Limit  
Press ENTER to save your selection

**How to select whether you wish the Dialer to forward on to the first telephone number programmed into section 3, any SMS that the Dialer receives. Some service providers will send a pay as you go SIM card an SMS to warn when credit is low– Section 0 (sub-section 6):**

(Default: SMS forwarding ON)

**Quick guide: Press 1 2 3 4 > PROGRAM > 0 > ENTER > 6 > ENTER > 1 > ENTER (0= No Forwarding, 1= Forwarding Active)**

1. Key in the four digit user <PASSWORD> code. (Factory default 1234).
2. Press PROGRAM > 0> ENTER > 6 > ENTER

(Note, pressing 6 after “0” means you enter section 0, sub-section 6)

Display will show 

Call Forwarding No Call Forwarding
---------------------------------------

Press 1 to select Call Forwarding or 0 to return to No Call Forwarding.

Display will show 

Call Forwarding Forwarding
-------------------------------

Press ENTER to save your selection

**NOTE:** You can also program this section by sending an SMS to the Dialer. See “Further Programming by SMS” later in this manual.

**How to select whether the Trigger Inputs are single or double knock. Double knock means that an input requires 2 separate triggers within 60 seconds to activate it– Section 0 (sub-section 7):**

(Default: instant - No Double Knock)

**Quick guide: Press 1 2 3 4 > PROGRAM > 0 > ENTER > 7 > ENTER > 1 > ENTER (0= Instant Activation, 1= Double Knock.)**

1. Key in the four digit user <PASSWORD> code. (Factory default 1234).
2. Press PROGRAM > 0 > ENTER > 7 > ENTER

(Note, pressing 7 after “0” means you enter section 0, sub-section 7)

Display will show 

Double Knock Not Active
----------------------------

Press 1 to turn Double Knock On or 0 to return to No Double Knock

Display will show 

Double Knock Active
------------------------

Press ENTER to save your selection

**How to select whether an Input is Normally Open or Normally Closed and is therefore activated by either a change from Open to Closed (default) or Closed to Open – Section 0 (sub-section 8):**

(Default setting is each Trigger is Normally Open)

Quick guide: Press 1 2 3 4 > PROGRAM > 0 > ENTER > 8 > ENTER > N > ENTER > 1 > ENTER  
(N= Input 1,2,3, 4,5 or 6      0 = Normally Open, 1 = Normally Closed)

1. Key in the four digit user <PASSWORD> code. (Factory default 1234).
2. Press PROGRAM > 0 > ENTER > 8 > ENTER  
(Note, pressing 8 after “0” means you enter section 0, sub-section 8)

Display will show

NO/NC
-------

Press 1 to program Input 1, press 2 to program Input 2 etc.

Display will show

NO/NC	1
NO	

Press 1 to change that Input to Normally Closed, Press 0 to return to Normally Open  
Press ENTER to save your selection

**How to select whether a “Power Failure” SMS is automatically sent to the 1<sup>st</sup> Tel No if there has been a Power Failure for more than 90 seconds from the external power supply. Note that this SMS will only be sent if a 9V back-up battery has been installed in the dialer – Section 0 (sub-section 9):**

(Default no SMS sent)

Quick guide: Press 1 2 3 4 > PROGRAM > 0 > ENTER > 9 > ENTER > 1 > ENTER  
(0= No SMS sent, 1= SMS sent.)

1. Key in the four digit user <PASSWORD> code. (Factory default 1234).
2. Press PROGRAM > 0 > ENTER > 9 > ENTER  
(Note, pressing 9 after “0” means you enter section 0, sub-section 9)

Display will show

Power Failure No SMS sent
------------------------------

Press 0 to have no SMS sent on Power failure

Display will show

Power Failure SMS sent
---------------------------

Press ENTER to save your selection

# How to turn the Dialer On/Off locally or remotely

## **How to Turn the Auto Dialer ON:** (Default ON. That means the Dialer will always be active or ON when power is first applied or re-applied to it. Turn Off to program and then turn back On and leave On)

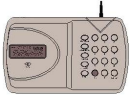

From the Dialer: Quick guide: Press 1 2 3 4 > ENTER

1. Check that the voice message and at least one phone number has been programmed into the Auto Dialer.
2. Press 1 2 3 4 ENTER. The Dialer will show "ON" on the display.
3. The triggers will become active after the delay time you have set has expired. (Default 0 seconds or instant)



From a Telephone: Quick guide: Call the Dialer and Press 1 2 3 4 > #

1. Check that the voice message and at least one phone number has been programmed into the Auto Dialer.
2. Call the Dialer (telephone number of the SIM card that has been installed). You will hear a long "beep" to indicate that the Dialer has answered. The Dialer's display will read "Call in"
3. Press 1 2 3 4 (4 digit code) followed by the # key. You will hear 2 beeps to indicate the Dialer has been turned on and the Dialer will automatically hang up
3. The triggers will become active after the delay you have set has expired. (Default set at 0 seconds, instant)



From a Text Message: Quick guide. Text the Dialer with 1 2 3 4 > #, then press the return key.

1. Check that the voice message and at least one phone number has been programmed into the Auto Dialer.
2. Text the Dialer (telephone number of the SIM card that has been installed) with the message: 1 2 3 4 # Ensure you then press the return key before pressing send so the cursor on your phone is flashing on the next line. The Dialer's display will briefly show a number, being the number of texts it has received to date.
3. The triggers will become active after the time you have set has expired. (Default set at 0 seconds, instant)

## **How to Turn Dialer OFF:**

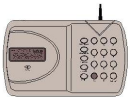

From the Dialer. This will also stop calls being sent out after it has been triggered: Press 1 2 3 4  
Dialer will show "OFF" on the display.



From a Telephone: Quick guide: Call the Dialer and Press 1 2 3 4 > \*

1. Call the Dialer (telephone number of the SIM card that has been installed). You will hear a long "beep" to indicate that the Dialer has answered. The Dialer's display will read "Call in"
2. Press 1 2 3 4 (4 digit code) followed by the \* key. You will hear 4 beeps to indicate the Dialer has been turned off and the Dialer will automatically hang up



From a Text Message: Quick guide. Text the Dialer with 1 2 3 4 > \*, then press the return key.

Text the Dialer (telephone number of the SIM card that has been installed) with the message: 1 2 3 4 \* Ensure you then press the return key before pressing send so the cursor on your phone is flashing on the next line. The Dialer's display will briefly show a number, being the number of texts it has received to date.

## **How to Stop the Dialer dialing the telephone numbers in sequence. The Auto Dialer will revert to the "OFF" mode and must be re-set to the "ON" mode as above:**

Quick guide: When the phone is answered, press <#> or <\*> on the receiving end's telephone keypad to stop the dialing sequence. If the Dialer does not immediately hang up, press # or \* again until it does.

When the Auto Dialer starts dialing, it will dial the first telephone number and repeat the pre-recorded voice message three times. The number dialed will appear briefly on the display and the display will then show the Tel number, in sequence, being called. If there is no response or acknowledgement (# or \* pressed) from that number, then it will dial the next number until all the programmed numbers for that trigger are dialed. If there is no acknowledgement from any of the phone numbers, it will display "NO ANSWER"

To stop this dial sequence, press the <\*> key on the telephone keypad that is receiving the call. At that time, the Auto Dialer will stop its dialing sequence and the alarm (if programmed) will stop. If the local alarm has been programmed as active, then pressing the <#> key will stop the dialing sequence, but the alarm will continue to sound until timed out. In both cases, the Dialer will remain ON, waiting for any further Trigger.

You can also stop the dial sequence at the Dialer's Keypad by entering the 4 digit code and pressing ESC. This will turn the Dialer OFF.

## How to Open Listen in

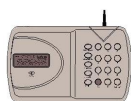

When answering a Voice Message from the Dialer: Quick Guide Press 9

1. If you wish to open "listen in" at any time, whilst receiving a voice message from the Dialer, press 9 on your telephone keypad.
2. To close the listen in, simply hang up



From a Telephone: Quick guide: Call the Dialer and Press 1 2 3 4 > 9

1. Call the Dialer (telephone number of the SIM card that has been installed). You will hear a long "beep" to indicate that the Dialer has answered. The Dialer's display will read "Call in"
2. Press 1 2 3 4 (4 digit code) followed by the 9 key to open listen in. To close, simply hang up.

## How to return the Dialer to Factory Default Settings

**(Note that this can only be done from the Dialer when the Dialer is in the OFF mode):**

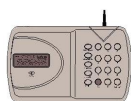

From the Dialer: Quick Guide Press 1 2 3 4 > \* > ENTER > 1 2 3 4 > \* > ENTER

1. Ensure the Dialer is in the OFF mode.
2. Press 1 2 3 4 > \* > ENTER, The display will read "Factory Default" Press 1 2 3 4 > \* > ENTER again to confirm you wish to return to Factory Default Settings or ESC to keep existing settings and exit programming



From a Text Message: Quick guide. Text the Dialer with 1 2 3 4 > \* 1 2 3 4 > \* (on new line)

Text the Dialer (telephone number of the SIM card that has been installed) with the message:

1 2 3 4 \* (press "return" to get onto a new line)

1 2 3 4 \* Press "send" to send the text

The Dialer's display will briefly show a number, being the number of texts it has received to date.

## How to turn the Outputs On and Off

The AD-06 has 4 outputs that can be programmed as:

1. **User only** (default setting) or **Event Follower + User**. “Event Follower” means output 1 activates when trigger 1 is activated, output 2 when trigger 2 is activated, output 3 when trigger 3 is activated and output 4 when trigger 4 is activated. Program an output as an Event Follower in Section 8, subsection 3.
2. **A 5 second momentary** output (default setting) or a **toggle latching output** (Section 8, sub-section 1). “Toggle Latching Output” means that the output remains ON until a further command turns it OFF again. Note that if the output has been programmed as a momentary output, a further programming section (Section 8, sub-section 2) selects whether it remains On for a time between 1 and 99 seconds before automatically turning Off.

### User Activation of the Outputs

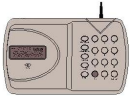

From the Dialer: Quick guide: Press 1 2 3 4 > 0 > 1 (the number of the output)

1. Press 1 2 3 4, followed by 0, followed by the number 1-4, being the number of the output you wish to turn ON (Output 1 in this example)
2. The Dialer will show “Output 1” on the display
3. If the output is a momentary output, it will remain active for the time which it has been programmed as remaining on for (1 to 99 seconds, default 5 seconds). If the output has been programmed as a toggle latching output, it will remain on until turned off.
4. To turn a Latching output off, Press 1 2 3 4, followed by 0, followed by the number 1-4, being the number of the output you wish to turn OFF



From a Telephone: Quick guide: Call the Dialer and Press 1 2 3 4 > 0 > 1 (the no of the output)

1. Call the Dialer, Press 1 2 3 4, followed by 0, followed by the number 1-4, being the number of the output you wish to turn ON (Output 1 in this example)
2. The Dialer will show “Output 1” on the display
3. If the output is a momentary output, it will remain active for the time which it has been programmed as remaining on for (1 to 99 seconds, default 5 seconds). If the output has been programmed as a toggle latching output, it will remain on until turned off.
4. To turn a Latching output off, Call the Dialer, Press 1 2 3 4, followed by 0, followed by the number 1-4, being the number of the output you wish to turn OFF



From a Text Message: Quick guide. Text the Dialer with 1 2 3 4 0 1 (“1” = Output Number)

Text the Dialer (telephone number of the SIM card that has been installed) with the message:

1 2 3 4 0 1 (“1” being the output you want to turn On/Off. That means, if you want to turn Output 2 On/Off, text the Dialer with 1 2 3 4 0 2)

1 Press “send” to send the text

The Dialer’s display will briefly show a number, being the number of texts it has received to date.

## How to initiate an immediate Test Call or Test SMS from the Auto Dialer

Note that if you wish to receive a Test Voice Call, you will first need to record a Test Message. See “How to record the Voice Messages” on Page 2. If you wish to receive a Test SMS, you will first need to create a Test SMS in Programming Section 9. The Test Call or SMS will be sent to those telephone numbers you have selected in programming section 6 (default is all numbers will receive a test call). Select whether you wish numbers to receive a Test Voice Call only, Test SMS only or both Voice Call and SMS in programming Section 0, sub section 1. You can cancel continued dial-out of the immediate Voice Message Test Call in the usual way by pressing \* or # on your phone.



From a Telephone: Quick guide: Call the Dialer and Press 1 2 3 4 > 5

1. Check that the Voice Test Call message and at least one phone number has been programmed into the Auto Dialer.
2. Check whether you wish all or some programmed Telephone numbers to receive such Voice Test Call message (default is all numbers). Go to programming section 6 to change as required.
3. Check whether you wish the Telephone numbers to receive a Voice Test Call Message only or an SMS as well as a Voice Test Call Message (default is a Voice Test Call Message only). If you wish any telephone numbers to receive an SMS stating "Test", program such numbers to receive an SMS as well in programming section 0, sub section 1
4. Call the Dialer (telephone number of the SIM card that has been installed). You will hear a long "beep" to indicate that the Dialer has answered. The Dialer's display will read "Call in
5. Press 1 2 3 4 (4 digit code) followed by the 5 key. The Dialer will hang up and the selected telephone numbers will then shortly receive an SMS first (if programmed to receive the same) followed by the Voice Test Call message

Note that you can also program the Dialer to send a periodic Test Call (daily, weekly or monthly) in Section 0, sub section 2 (default is no periodic Test call).

## Programming the Dialer by SMS

As well as being able to program the Dialer from its keypad, you can also program certain sections via SMS message by texting the number of the SIM card that has been installed in the Dialer. Such programming can be done even when the Dialer is in the ON mode, although power must, of course, be applied at that time to the Dialer. Ensure that you send your message on new lines whenever indicated below (a "return" in an SMS is the equivalent of "Enter" on the keypad).

### How to Change the User PASSWORD: (As page 5 above - factory default 1234)



**Quick guide. Text the Dialer with 1 2 3 4 > \* > New password > \* (important: all on one line)**

Text the Dialer with the message:

1 2 3 4 \* New 4 Digit Password here \*      Press "send" to send the text

The Dialer's display will briefly show a number, being the number of texts it has received to date.

### How to Program Phone Numbers – ( As Section 3 ) :



**Quick guide. Text the Dialer with 1 2 3 4 p1 > Telephone No (on new line)**

To program the first telephone number in sequence, Text the Dialer with the message:

1 2 3 4 p1    (press "return" to get onto a new line)

Telephone Number (up to 16 digits) \*      Press "send" to send the text

The Dialer's display will briefly show a number, being the number of texts it has received to date.

To program the second telephone number in sequence, Text the Dialer with the message:

1 2 3 4 p2    (press "return" to get onto a new line)

Telephone Number (up to 16 digits) \*      Press "send" to send the text

The Dialer's display will briefly show a number, being the number of texts it has received to date.

Repeat for all 9 numbers as required changing the number after "p"



## **How to Designate Telephone No's to TRIGs 1,2,3,4,5 and 6 + the Test Call – ( As Section 6):**

Only these Telephone Numbers will be called/SMS sent to on activation of the respective trigger input.



**Quick guide. Text the Dialer with 1 2 3 4 i1 (the trigger no) > Select Numbers 1-9 (on new line)**

To select those numbers the Dialer will call or send an SMS to after input trigger 1 has been activated, Text the Dialer with the message:

1 2 3 4 i1 (press “return” to get onto a new line)

Enter now those numbers 1,2,3,4,5,6,7,8 and 9 that you wish to call upon activation of input trigger 1. For example, if you enter 123, it means only the first, second and third numbers in sequence will be called. Press “send” to send the text. The Display will briefly show a number, being the number of texts it has received to date.

To select those numbers the Dialer will call or send an SMS to after input trigger 2 has been activated, Text the dialer with the message:

1 2 3 4 i2 (press “return” to get onto a new line)

Enter now those numbers 1,2,3,4,5,6,7,8 and 9 that you wish to call upon activation of input trigger 1. For example, if you enter 246, it means only the second, fourth and sixth numbers in sequence will be called. Press “send” to send the text. The Display will briefly show a number, being the number of texts it has received to date.

Repeat for all 9 numbers as required changing the number after “i”. You can also program the numbers to be called on the Test Message by sending as i0

## **How to create an SMS message to for a Trigger Input – (As Section 9):**

A MESSAGE= Max 32 Digits message including spaces



**Quick guide. Text the Dialer with 1 2 3 4 s1\* > SMS (on new line)**

To program the text message for trigger input 1, Text the Dialer with the message:

1 2 3 4 s1\* (press “return” to get to a new line)

Enter the Text (up to 32 digits) \* Press “send” to send the text

The Dialer’s display will briefly show a number, being the number of texts it has received to date.

To program the text message for trigger input 2, Text the Dialer with the message:

1 2 3 4 s2\*

Text (up to 16 digits) \* Press “send” to send the text

The Dialer’s display will briefly show a number, being the number of texts it has received to date.

Repeat for all 9 numbers as required changing the number after “s”

## **How to select whether you wish the Dialer to forward on to Tel No 1 any SMS that it receives. The reason for this is because some service providers will send a pay as you go SIM card an SMS to warn when credit is low – (As Section 0 sub-section 6):**



**Quick guide. Text the Dialer with 1 2 3 4 f1 > 1 or 0**

To program the Dialer to forward a received SMS message to Tel No 1, Text the Dialer with the message:

1 2 3 4 f1 Press “send” to send the text

f0 means Forwarding will be OFF

f1 means Forwarding will be ON

## How to select whether the Dialer sends out a monthly Test Call or SMS – As Section 0 (sub-section 2):



Quick guide. Text the Dialer with 1 2 3 4 t1 > 1 or 0

To program the Dialer to send a monthly test call to the number or numbers that have been programmed in Section 6 (select “0” for the Test Call), Text the Dialer with the message:

1 2 3 4 t1                      Press “send” to send the text

t0 means Forwarding will be OFF

t1 means Forwarding will be ON

## How to send texts from the Dialer to Tel No 1 with details of the Dialer’s essential programming



**From a Telephone: Quick guide: Call the Dialer and Press 1 2 3 4 > 1**

1. Call the Dialer (telephone number of the SIM card that has been installed). You will hear a long “beep” to indicate that the Dialer has answered. The Dialer’s display will read “Call in”
2. Press 1 2 3 4 (4 digit code) followed by the 1 key. The Dialer will automatically hang up and start sending SMS’s to Telephone Number 1 with the following information:
  - p1  
p2 etc.  
Being the telephone numbers that have been programmed to dial out to in sequence
  - s1  
s2 etc.  
Being SMS’s that may have been entered for any trigger input
  - i1  
i2 etc.  
Being the telephone numbers that have been assigned to each input trigger to dial out to
  - t0  
t1  
Whether a monthly test call has been activated (t0 = no monthly test call, t1 = monthly test call)
  - f0  
f1  
Whether SMS forwarding has been activated (f0 = no monthly test call, f1 = monthly test call)

## Other Useful Information

### How to Change the back-up battery (if used):

**Important:** It is recommended to change the back-up battery pack at least once a year even if not low.

1. First make sure that the Auto Dialer is OFF. Then release it from the wall.
2. Remove the battery door and remove the old battery. Re-insert a new 9V BATTERY (Lithium preferred).
3. Re-fit the battery door and hang the Auto Dialer back onto the wall.

### **Note of caution**

1. Do not mount the Auto Dialer in areas that are exposed to extreme heat or moisture, as this could adversely affect the performance of the system.
2. Use only a damp cloth and general household cleaning agent to wipe the unit clean. Do not use turpentine, thinner, gasoline or similar substances to clean the unit

## Trouble Shooting

Q	I have connected the Dialer to an Alarm Panel. The panel has activated, but there is no message appearing on the Dialer's LCD display and it is not dialling out.
A	<p>Check the following carefully:</p> <ol style="list-style-type: none"> <li>I. Does the Dialer have a 12V supply – either from the panel or via a 500ma 12V mains adaptor?</li> <li>II. Does the Dialer have a SIM card fitted? The words “On GSM Ready” should be showing in the display to indicate that a SIM card has been fitted and that a network has been found.</li> <li>III. Have you fitted your SIM card correctly? The SIM card must be fitted firmly into the holder in the correct orientation.</li> <li>IV. Have you made the correct connections to the Trigger 1 and 2 inputs (either switched negative or relay)?</li> <li>V. Is the Dialer On/Armed? Remember that if you have been programming, then it will have been in the Off mode and you will have to go back to On/Armed mode again. Enter your 4 digit code + Enter to turn On/Armed.</li> <li>VI. Has your SIM card been disabled by the Network Provider? Most Pay-As-You-Go SIM cards will be disabled after a certain period if they are inactive. Some Network Providers now also require voice usage rather than text usage to continue activation. Check first whether the Network Provider you are using accepts a regular text message to continue activation and over what period of time. Then go to Programming Section 0 to enable a Self-Test Text Message. If your Network Provider requires voice usage only, consider changing Providers or use a Contract SIM.</li> </ol>
Q	The Dialer's input has been activated correctly and a message has appeared in its display to indicate this, however, the voice message is not being received by the number it is meant to be dialling.
A	<p>Check the following carefully:</p> <ol style="list-style-type: none"> <li>I. Have you activated the correct Dialer trigger? You may have programmed different numbers to call out for Trigger 1 and Trigger 2.</li> <li>II. In Section 3 Programming, have you entered the correct telephone number to call and/or entered a wrong digit by mistake?</li> <li>III. If you think the Dialer should be dialling a particular number, have you actually de-selected that number for that trigger by mistake? Go to Programming Section 6. To check the numbers that are being dialled in sequence for Trigger 1, press 1234 (code) &gt; Program &gt; 6 &gt; Enter &gt; 1. You should now see various numbers between 1 and 0 illuminated. If a number is unlit it means it is <u>not</u> being dialled for Trigger 1. Toggle numbers on/off by pressing that number on the keypad. <u>A number must be lit in Section 6 if it is being dialled for that trigger.</u></li> <li>IV. Have you recorded a voice message for that trigger ? Enter your 4 digit code, followed by “Play” followed by the number of the trigger input to check a message has been recorded correctly.</li> <li>V. Are you sure that the telephone number you are calling has been selected to receive a voice message ? Section 0, subsection 1 selects, tel number by tel number whether that particular number should receive a voice message only, an SMS only or both a voice message and an SMS.</li> </ol>

Q	The Dialer's input has been activated correctly and a message has appeared in its display to indicate this, however, it is not then dialling out and an error message is appearing on the LCD display.
A	<p>Check the following carefully:</p> <ol style="list-style-type: none"> <li>I. Have you programmed at least one telephone number to the Dialer? If the Dialer is showing a "no answer message" in the display it means no telephone number has been programmed. Press 1234(code) +ESC to exit. Then, go to Programming Section 3 and enter at least one telephone number.</li> <li>II. Have you deleted a telephone number by mistake? Go to Programming Section 3. To check whether the 1<sup>st</sup> telephone number you think you have programmed in is in the Dialer's memory correctly, Press 1234(code)&gt;Program&gt;3&gt;Enter&gt;1&gt;Enter. You should now see that telephone number. Press Enter again to Exit programming. If you don't see a telephone number there, enter the number again and press Enter to exit.</li> <li>III. Have you de-selected a number to be dialled out in sequence for that trigger by mistake? Go to Programming Section 6. To check the numbers that are being dialled in sequence for Trigger 1, press 1234(code)&gt;Program&gt;6&gt;Enter&gt;1. You should now see various numbers between 1 and 0 illuminated. If a number is unlit, it means it is <u>not</u> being dialled for Trigger 1. Toggle numbers on/off by pressing that number on the keyboard. <u>A number must be lit in Section 6 if it is being dialled for that trigger.</u></li> <li>IV. Is the Dialer in a location where it can obtain a good GSM signal? Check the Network signal strength by pressing ENTER (you can do this whilst the Dialer is both in the ON and OFF modes). The Dialer should be installed in a location where the signal strength displayed shows at least 2 or above. Move the Dialer to a different location in the premises or use an alternative network SIM card. If the Dialer has been mounted in or on metal, this will be acting as a shield, so carefully unscrew the existing antenna and replace it with a remote antenna plus cable.</li> </ol>
Q	I can't cancel the remote dial-out remotely by pressing, on the remote telephone hand-set, either * (cancel dial out and alarm sound if programmed) or # (cancel dial out only, alarm sound will continue until time out).
A	Have you waited until the message has ended? You cannot cancel until it has been played to you at least once.
Q	I have inserted a SIM card, but the LCD display is showing "SIM Error"
A	<p>Check the following carefully:</p> <ol style="list-style-type: none"> <li>i) Remove the SIM card and re-insert, making sure a good connection is made</li> <li>ii) Carefully clean both the golden section on the rear of the SIM card and the golden pins in the SIM card holder</li> </ol>
Q	I am not receiving any SMS's, either after a Trigger or after I have initiated an immediate Test SMS
A	<p>Check the following carefully.</p> <ol style="list-style-type: none"> <li>i) Have you programmed a Text for either the Trigger input or the Test Call (Section 9) ?</li> <li>ii) Have you programmed that Telephone number to receive a text (Section 0, subsection 1). A telephone number must be programmed to receive either an SMS only or SMS plus Text</li> </ol>
Q	Tel No 1 has not received a "power fail" SMS after external power was removed
A	<p>Check the following carefully:</p> <ol style="list-style-type: none"> <li>i) Is there a good 9VPP3 back-up battery inside the battery compartment ?</li> <li>ii) You need to wait at least 2 minutes after power fail to receive this text, have you done so ?</li> </ol>
Q	I have programmed the Dialer to send out regular Test Calls and/or SMS's, but none are being received
A	Check whether you have actually recorded a Test Message or written a Test SMS