

Intruder alarm system

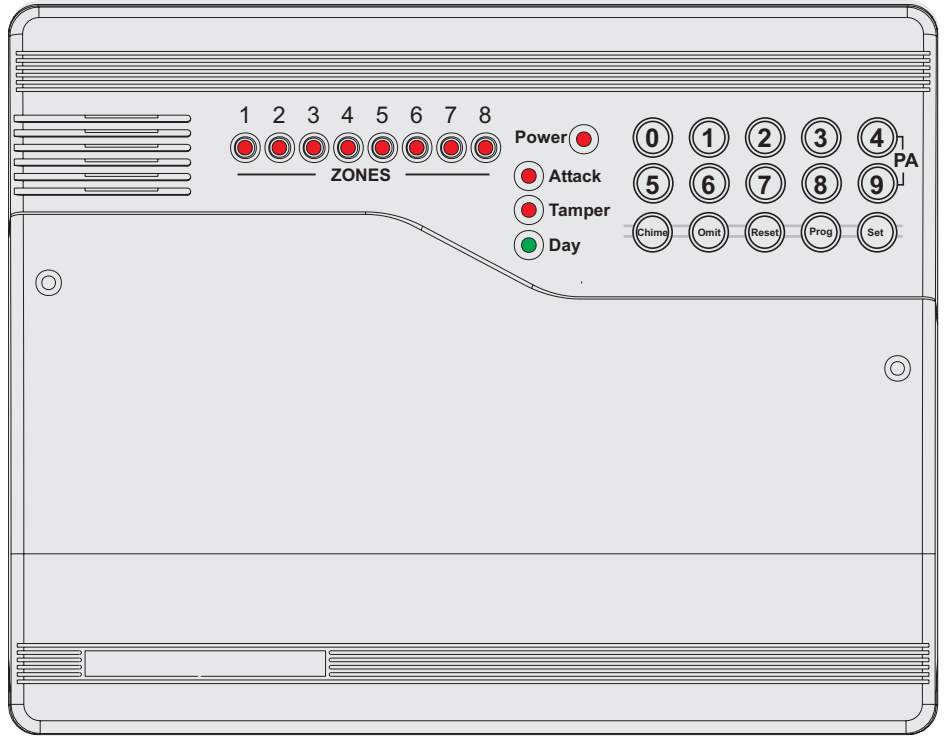

Operating Instructions

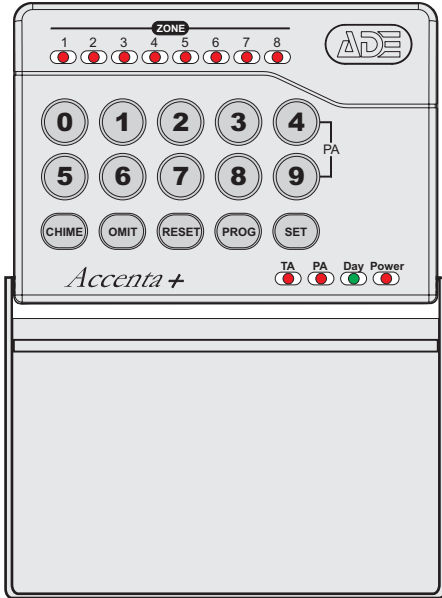

Servicing organisation (Installer) name: _____

Telephone number: _____

Date of installation: _____

Account number: _____

New
remote
keypad

System installation

This booklet tells you how to operate your intruder alarm system. To simplify this booklet we have assumed that the alarm system has been installed by a professional intruder alarm system installer (the installer), and that the system is operated in a “typical” way. Aspects of your system that are not “typical” will be described by your installer.



If you have any questions about your intruder system, then consult your installer, see contact details on the front page.

Codes

To operate the alarm system you will need to use a code. A code is 4 digits long, and can be any number from 0000 to 9999. By default the code is **0 1 2 3** but you should change this as soon as possible.

Alarm System Operation

This booklet describes two versions of the alarm system. The **Optima** version has the keypad and indicators on the main control panel. The **Accenta** version has the keypad and indicators on a small remote keypad. You operate the alarm system by pressing buttons on the keypad and viewing the indicators. Both alarm systems work the same way. Both **Accenta** and **Optima** systems can be fitted with an optional remote keypad.

Personal Attack

If you are under threat, or are being attacked, you can activate the alarm by pressing the **4** and **9** keys at the same time on any keypad. The alarm system will produce a loud alarm sound, and the external siren will be turned on.

Fire Zones

One or more Zones on your alarm system may have a Fire or Smoke detector connected to it. In the event of a fire the alarm system will produce a distinctive two-tone fire alarm sound, and the outside siren will pulse 2 seconds on, 2 seconds off. You should leave the premises immediately, and only re-enter when it is safe to do so. The alarm can be silenced by entering your code.

Power Indicator

The **Power** indicator on the control panel or keypad will light whenever the mains power supply is present. If mains power fails then the **Power** indicator will go out, but the system will run from its backup battery for several hours. If the **Power** indicator goes out when mains power is present then a fault may have developed on your system and you should contact your installer.

Warning beeps

Your system may produce warning beeps to inform you of a potential problem. A single beep every 5 minutes tells you that the system needs to be serviced. You should call your installer to arrange a service visit. The system will continue to operate correctly in all respects.

A double beep every 5 minutes tells you that the telephone line that the alarm system uses is not available or has failed. This may be due to someone using a telephone on the same line. If this problem persists you should contact your installer to rectify the problem. Your alarm system will continue to operate, but it cannot send alarm messages via the telephone line.

Signalling Device

Your alarm system may have been fitted with a signalling device. This device uses the telephone line to send an alarm message to an Alarm Receiving Centre in the event of an alarm. The operator at the ARC may request the police to attend your premises.

How to set the system

When you leave your premises you will need to set (or turn on) the intruder alarm system.

1. Before setting the system you should ensure that the premises have been completely vacated and that all doors and windows are closed. Ensure that pets do not have access to the protected areas as they can cause a false alarm.

The green **Day** indicator should be lit.

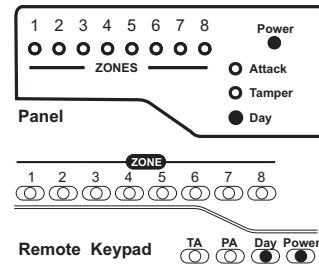

2. Enter your **code** 0 1 2 3 and check that the system is clear (none of the zone indicators are lit).

The system will now produce an exit beep tone. You should leave the premises by the exit route recommended by your installer. The system will set when the exit beep tone stops.



3. The **Day** indicator will go out. You should wait until you hear that the exit beep has stopped before assuming that the system has set.

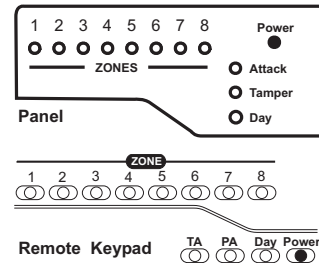

How to Unset the system

When you enter your premises you will need to unset (or turn off) the system.

1. Enter your premises by the route recommended by your installer. The system will produce an entry beep tone.

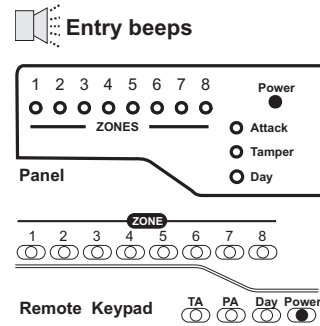

2. Key in your code **0** **1** **2** **3**, and the entry tone will stop. The green **Day** indicator will light.

If any Zone, TA (Tamper) or PA (Attack) indicator lights up then an alarm has occurred, and an intrusion may have taken place. Seek assistance before investigating further as intruders may still be on the premises. Then reset the system (refer to page 7).

Note that when you enter your premises you will have a short period of time, usually 30 seconds, to key in your code. If you fail to do this the system will go into alarm. Key in your code to stop the alarm.

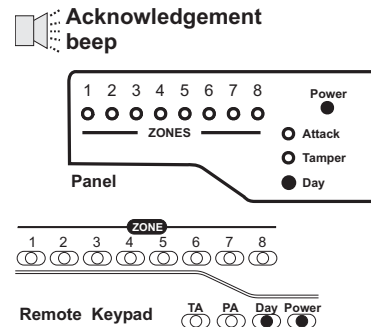

How to part set the system

If your installer has programmed your system for **part set** operation you will be able to set some zones of the system while others remain unset. Part set operation is often used at night time, and it will permit you to freely walk around the bedrooms while the living area and outside doors are protected. Your system may have 2 part-set programs called Program 2 and Program 3.

1. Before part-setting the system you should ensure that all doors and windows are closed. Ensure that pets do not have access to the protected areas. Your installer may have instructed you to use a different keypad to the one normally used to set the system.

The green **Day** indicator should be lit.

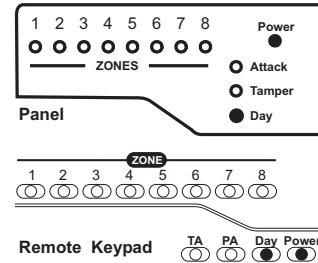

2. Enter your **code** 0 1 2 3. The Exit beep will start.



3. Press the **Prog** key. The exit tone will stop and Zone indicators 1 to 3 will light.

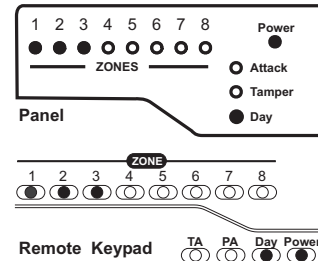

4. Press 2 or 3 to select part-set program 2 or 3. You must now leave the protected zones. The system will set after a short time.



Note: There will be no exit beeps if **silent set** exit mode was programmed.

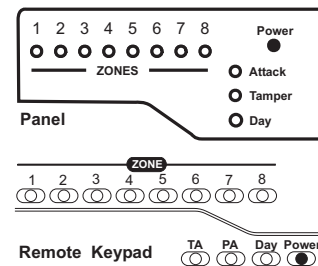

How to silence an alarm

If your system goes into alarm then be aware that intruders may be in the premises. Seek assistance before investigating the cause of the alarm.

1. Enter your code 0 1 2 3.

The alarm will stop, and the Zone, TA (Tamper) or PA (Attack) indicators will light to show the cause of the alarm. When 2 or more indicators are lit, the flashing indicator shows the first alarm, and the steady indicators show the second and subsequent alarms.

3. You may need to cancel Police response. Your installer will provide details of how to do this.

You will now need to reset the system, as described in the following section.

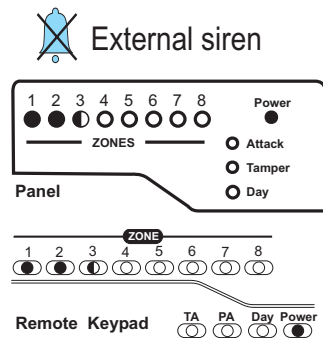

How To Reset After An Alarm

After any alarm you will need to reset your system so that it can be used normally. Your installer may have programmed the system to be reset by you, the installer, or by Anti-code.

- Press the  key.

If the Zone, TA (Tamper) or PA (Attack) indicators all go out and the **Day** indicator lights then the system has been reset.

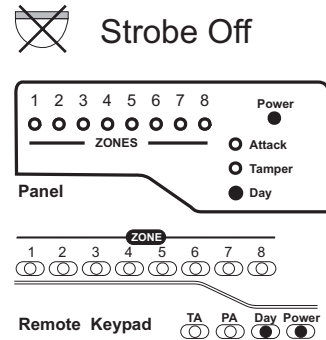

If any of the indicators continue to flash then the system has been programmed to be reset by the installer. In this case you must call the installer to reset the system.

If all indicators light steady (not flashing), and the keypad stops working, then the system has entered a fault-lockout. You must call the installer rectify this fault.











Anti code reset

The installer may instruct you to reset the system by an Anti-code.

- Press . The system will now display a sequence of 4 numbers by using the Zone indicators. Each number will be displayed for a few seconds, the system will beep, and display the next number. You can repeat this sequence by pressing **Reset** again. Write down the 4 digit number and quote it to the installer
- The installer will tell you a 6 digit anti-code.  Call your installer for the **anti-code**.
- Key in the 6 digit code to reset the system.

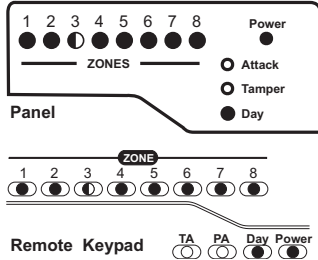

How to Omit zones

If you cannot set the alarm system because a detector is faulty and in constant alarm you may need to omit its zone from the alarm system. A zone which has been omitted cannot cause an alarm.

1.	Key in your code to start the exit procedure. For more information see How to set the system or How to set program 2 or 3.	 Exit beeps
2.	Press  and the exit beep tone will stop, and the indicators will display all zones being used.	 Exit beeps
3.	Press the zone numbers to be omitted  , these indicators will now flash. If a flat reject tone is produce then the zone cannot be omitted.	
4.	When you have finished press  to set the system.	 Exit beeps  10 seconds insistent beeps

How to Quick Set the system

When you set the system you will usually have about 30 seconds to exit the premises. This also means that you need to wait 30 seconds for the system to set. You can reduce this time to just 5 seconds by carrying out a second 'set' a Quick Set.

1.	Key in your code to start the exit procedure. The exit beep tone will start. For more information see How to set the system, or How to set program 2 or 3.	 Exit beeps
2.	Press  to Quick set the system and the exit beep tone will change to a faster, insistent, tone. The system will set in 5 seconds, and the exit tone will stop.	 5 seconds insistent beeps

How to set up Chime Zone

Chime is a low security facility for use when the system is unset. It is particularly useful in a shop to warn of customers presence, or in a house to warn when a back door has been opened. When a Chime zone detects movement the system will produce a brief two-tone sound, and the Zone indicator will light.

To set any Zone to Chime:

1. The green **Day** indicator should be lit.

Press the  button, and the system will produce a brief chime tone, the **Day** indicator will flash, and the Zone indicators will light to show those Zones that are already set-up for Chime (possibly none).

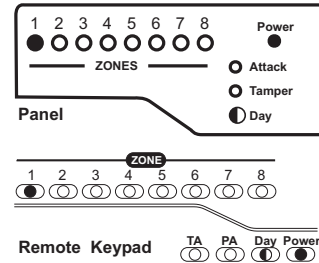

2. Momentarily press the number of the zone to toggle it in and out of chime.

For this example we have Zone 1 in chime and we want to de-select Zone 1 chime and select Zones 2 and 3 to chime.

Press   .

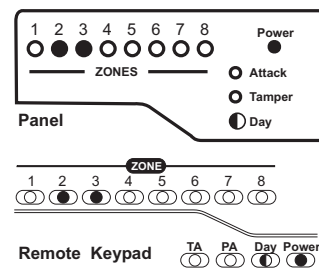

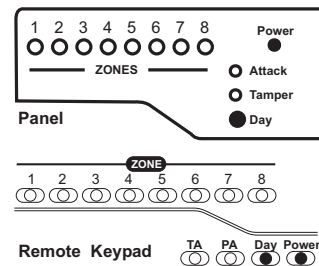

3. When you have finished using the Chime mode press .

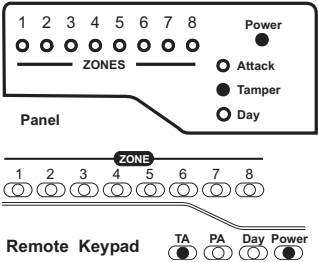
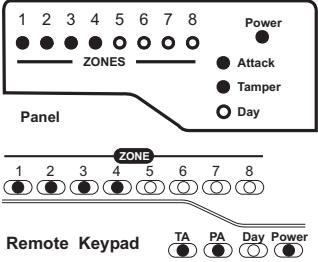

How to change your User code

You should change your main code regularly to prevent potential intruders from knowing your code. All codes are 4 digits long. The factory set main code is **0 1 2 3** but this may have been changed.

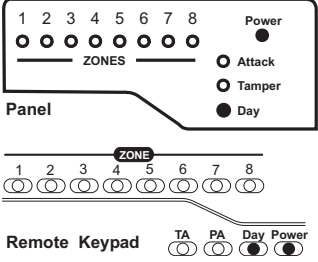
<p>1.</p>	<p>Press Prog and now enter your code 0 1 2 3. The TA (Tamper) indicator will light and the Day indicator will go out to indicate that you are in Programming mode.</p>	
<p>2.</p>	<p>Press 8 to select user code reprogram. The Attack and Zone indicators 1 to 4 will be lit to prompt you to enter a new code.</p>	
<p>3.</p>	<p>Key in your new code n n n n.</p>	
<p>4.</p>	<p>If the code is accepted the system will produce a series of rapid beeps.</p> <p>If the code is rejected, for example if it is already in use, the system will produce a flat reject tone. You must go back to step 2.</p>	
<p>5.</p>	<p>Press Reset to exit programming mode. The TA (Tamper) indicator will go out and the Day indicator will light.</p>	



Example

If your code is 0123 and you wish to change it to 5678 then:

Press **Prog 0 1 2 3 8 5 6 7 8 Reset**.

How to change your second code

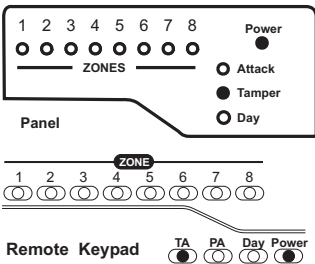
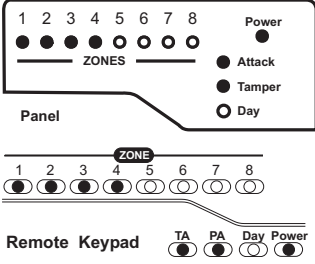
Your alarm system can have a second user code. You may find it useful to set-up this second code for use by a neighbour for use when you are on holiday. The second user code operates like your user code, but it cannot be used to change or delete your code.

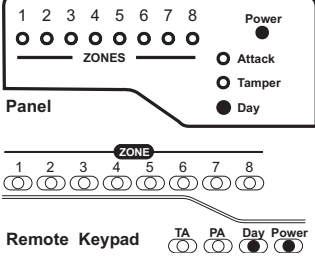
<p>1.</p>	<p>Press Prog and enter your code 0 1 2 3. The TA (Tamper) indicator will light and the Day indicator will go out to indicate that you are in Programming mode.</p>	 <p>The diagram shows the alarm panel with 8 ZONES (1-8) and indicators for Attack, Tamper, and Day. The remote keypad shows TA, PA, Day, and Power indicators. In this step, ZONES 1-4 are lit, and the Day indicator is off.</p>
<p>2.</p>	<p>Press 7 to select second code reprogram. The Attack and Zone indicators 1 to 4 will be lit to prompt you to enter a new 4 digit <i>user code</i>.</p>	 <p>The diagram shows the alarm panel with 8 ZONES (1-8) and indicators for Attack, Tamper, and Day. The remote keypad shows TA, PA, Day, and Power indicators. In this step, ZONES 1-4 are lit, and the Attack indicator is lit.</p>
<p>3.</p>	<p>Key in the new second code n n n n.</p>	
<p>4.</p>	<p>If the code is accepted the system will produce a series of rapid beeps.</p> <p>If the code is rejected, for example if it is already in use, the system will produce a flat reject tone. You must go back to step 2.</p>	 <p>Rising beeps</p>
<p>5.</p>	<p>Press Reset to exit program mode. The TA (Tamper) indicator will go out and the Day indicator will light.</p>	 <p>The diagram shows the alarm panel with 8 ZONES (1-8) and indicators for Attack, Tamper, and Day. The remote keypad shows TA, PA, Day, and Power indicators. In this step, ZONES 1-4 are lit, and the Day indicator is lit.</p>

Example

If your second code is 1234 and you wish to change the code to 7890, then:

Press **Prog** **1** **2** **3** **4** **7** **7** **8** **9** **0** **Reset**.



How to delete your second code

You can delete the second code to prevent it from being used.

1. Follow steps 1 and 2 of **How to change your second code** and press **Omit**.
2. Follow steps 5 of **How to change your second code**.

How to change the Duress code

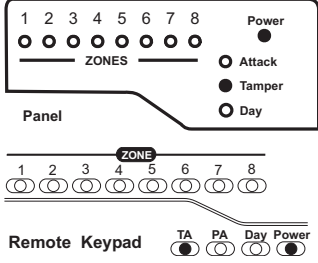
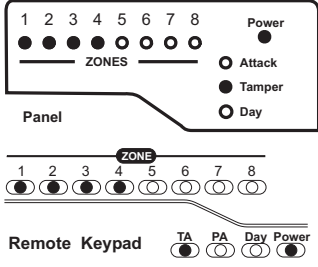
Your alarm system can have a duress code. The Duress code is used in a hold-up situation where there is pressure to set or unset the system. The Duress code operates like your normal code but in addition it will silently send a signal to the Alarm Receiving Centre who will inform the Police. The duress code can only be changed by the main user. Note the Duress code facility is not applicable to **Optima compact G3** system.

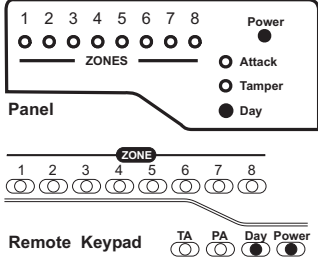
<p>1. Press Prog and enter your code 0 1 2 3. The TA (Tamper) indicator will light and the Day indicator will go out to indicate that you are in Programming mode.</p>	
<p>2. Press 9 to select Duress code programming. The Zone indicators 1 to 4 will light to prompt you for a new code.</p>	
<p>3. Now enter your new duress code n n n n.</p>	
<p>4. If the code is accepted the system will produce a series of rapid beeps.</p> <p>If the code is rejected, for example if it is already in use, the system will produce a flat reject tone. You must go back to step 2.</p>	
<p>5. Press Reset to exit programming mode. The TA (Tamper) indicator will go out and the Day indicator will light.</p>	

Example

If you need to change the duress code to 6543, then:

Press **Prog** **0** **1** **2** **3** **9** **6** **5** **4** **3** **Reset**.

How to view the event log

The event log keeps a memory of the last 8 alarm events.

1. Press **Prog** and enter your code **0 1 2 3**.
The **TA (Tamper)** indicator will light and the **Day** indicator will go out to indicate that you are in Programming mode.

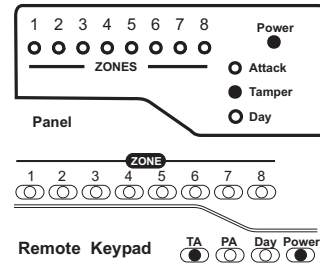

2. Press **Chime**. The system will display 8 alarm events in sequence, with the last (most recent) alarm first. When 2 or more indicators are lit, the flashing indicator shows the first alarm, and the steady indicators show the second and subsequent alarms.

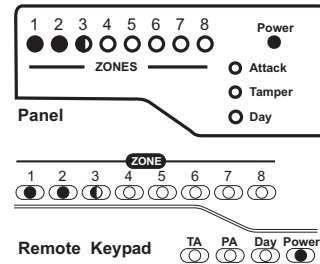

The example here shows an event where Zone 3 was the first zone in alarm followed by Zones 1 and 2.

3. All 8 alarm events will be displayed in sequence, with a 5 seconds delay between each event. You can cause the display to pause by pressing **Chime**. You can also display a specific event by pressing its event number, **1** to **8**.



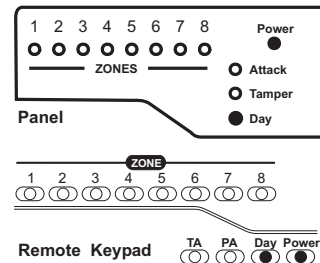

4. Press **Reset** to exit the event log and press **Reset** again to exit program mode. The **TA (Tamper)** indicator will go out and the **Day** indicator will light.

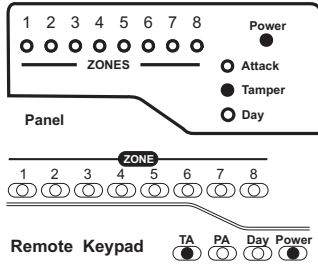
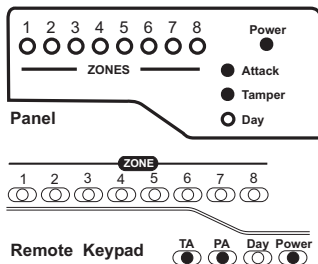

How to test your alarm system

You should check that your alarm system still works correctly by periodically carrying out the alarm system tests described here.

How to test the Strobe, External Siren and Internal Sounders

<p>1.</p>	<p>Press Prog and enter your 4 digit <i>user code</i> 0 1 2 3. The TA (Tamper) indicator will light and the Day indicator will go out to indicate that you are in Programming mode.</p>	
<p>2.</p>	<p>Press 0 to select alarm test mode. The Attack indicator lights to indicate that you are in alarm test mode.</p>	
<p>3.</p>	<p>Strobe test</p> <p>Press 2 to test the strobe light. This is normally mounted on the external siren. It should produce a bright flash at a rate of 1 flash every few seconds. Press 0 to stop this test.</p> <p>Siren (Bell) Test</p> <p>Press 3 to test the external siren, this should produce a loud alarm sound. Press 0 to stop this test.</p> <p>Sounder Low Volume Test</p> <p>Press 4 to test the Low volume sounder. This should produce a low volume alarm sound. Press 0 to stop this test.</p> <p>Sounder High Volume Test</p> <p>Press 5 to test the High volume sounder. This should produce a high volume alarm sound. Press 0 to stop this test.</p>	<p> Strobe On <input type="radio"/> Day</p> <p> External siren <input type="radio"/> Day</p> <p> Internal low volume sound <input type="radio"/> Day</p> <p> Internal high volume sound <input type="radio"/> Day</p>

Walktest

Press **6** to carry out a walktest. Walk around your property, and in turn cause each of the detectors to go into alarm. Also, open and close all door and windows that are protected by the system. For each detector (including door or window sensor) that is activated the system will produce a series of beeps, and the associated zone indicator will light.

Press **0** to stop this test.



IMPORTANT: Do not test any "Personal Attack" buttons during the walktest, since these are still active and will cause a full alarm.

If any of the alarm tests fail, or you are unsure of the correct procedure, contact your installer.

4.

Press **Reset** to exit Alarm test and press **Reset** again to exit program mode. The **TA (Tamper)** indicator will go out and the **Day** indicator will light.

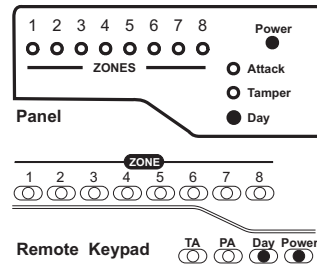

Operating instructions

External siren Time: _____

Siren delay _____

Area protected	Zone name	Program 1	Program 2	Program 3
Zone 1				
Zone 2				
Zone 3				
Zone 4				
Zone 5				
Zone 6				
Zone 7				
Zone 8				

T = Timed (Entry/Exit - Zone)

TI = Time Inhibited (Access zone to keypad)

I = Immediate (All zones armed to give full alarm)

For Technical Support

 : 0906 302 0999

This is a premium rate line, calls are charged at 50 pence per minute



The panels conform to the requirements of the European EMC and Low Voltage directives, and carries the CE mark.

Novar ED&S
The Arnold Centre
Paycocke Road
Basildon
SS14 3EA